

# FIRESTOPPING OF SERVICE PENETRATIONS

## BEST PRACTICE IN DESIGN AND INSTALLATION



This guide is the result of a collaboration between these not-for-profit associations:



# FIRESTOPPING OF SERVICE PENETRATIONS

## BEST PRACTICE IN DESIGN AND INSTALLATION

There has been supplementary support for this guide from the following organisations:



**FSi** develops and manufactures a full range of built-in passive fire protection systems to protect infrastructure and assets for new and existing buildings around the world. The key here is the reference to systems and not individual products. FSi manufactures passive fire protection, air permeability, movement, water permeability and acoustic isolation systems as well as general construction sealants. FSi also offers support and training through its highly experienced technical team and prides itself on the highest level of testing and technical expertise that has been built up over many years.

[fsiltd.com](http://fsiltd.com)



**Warringtonfire**, part of the Element

Group, specialises in providing a comprehensive range of independent fire testing, assessment, engineering and certification services to international markets from a network of accredited sites across the globe including Europe, the Middle East, Asia and Australia. They exist to help customers make certain that the materials, products and systems that they make are safe, quality, compliant and ultimately fit for purpose, leveraging 40 years of testing experience and global testing capabilities.

[warringtonfire.com](http://warringtonfire.com)



**ROCKWOOL**

**Rockwool** Limited is part of the

Rockwool Group, with its UK factory based in Bridgend, South Wales offering a full range of sustainable, non-combustible stone wool insulation products for the construction industry. With over 80 years expertise, it is perfectly suited to tackle many of today's biggest sustainability and development challenges, from fire resilience to energy consumption and noise pollution.

[rockwool.co.uk](http://rockwool.co.uk)

# CONTENTS

<b>FOREWORD 1.....</b>	<b>5</b>
<b>FOREWORD 2 .....</b>	<b>6</b>
<b>INTRODUCTION .....</b>	<b>7</b>
<b>SCOPE.....</b>	<b>8</b>
<b>1 PREPARATION AND BRIEFING.....</b>	<b>14</b>
<b>2 CONCEPT DESIGN.....</b>	<b>16</b>
<b>3 SPATIAL COORDINATION .....</b>	<b>20</b>
<b>4 TECHNICAL DESIGN.....</b>	<b>41</b>
<b>5 MANUFACTURING AND CONSTRUCTION.....</b>	<b>48</b>
<b>6 HANDOVER.....</b>	<b>52</b>
<b>7 USE .....</b>	<b>53</b>
<b>APPENDIX A REGULATIONS, STANDARDS AND INDUSTRY GUIDANCE .....</b>	<b>54</b>
<b>APPENDIX B CASE STUDY .....</b>	<b>61</b>
<b>REFERENCES.....</b>	<b>65</b>
<b>ACKNOWLEDGEMENTS .....</b>	<b>69</b>

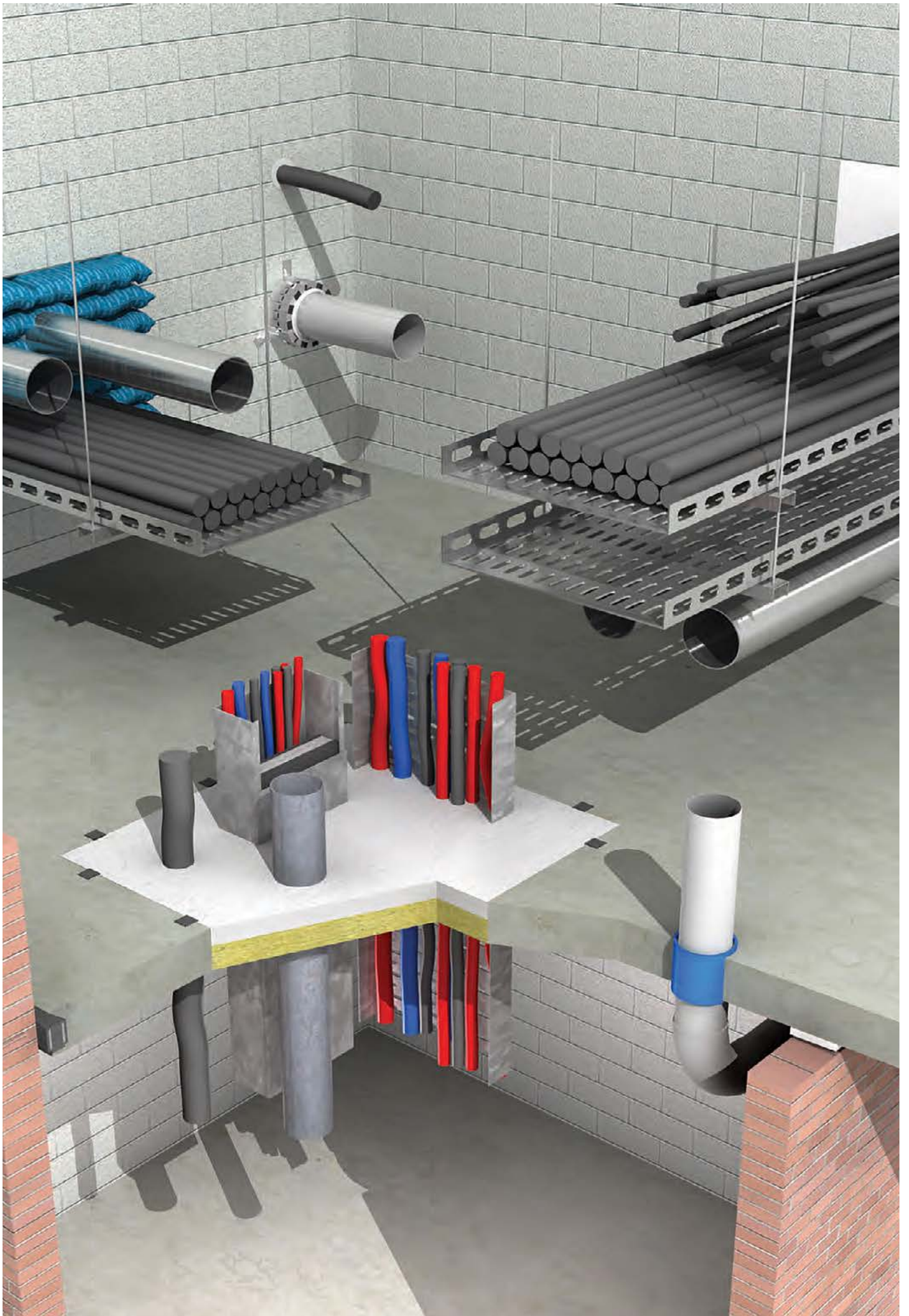

# FOREWORD



**This document is the result of a collaboration between a number of relevant trade bodies and organisations representing the wider construction and fire safety industries, and it is an example of the collaborative working and acceptance of professional responsibility throughout the supply chain that must become a feature of the industry's culture from now on.**

Knowledge that is produced through collaboration and shared freely throughout the entire supply chain is key to the improvements required in building safety and quality. I would, therefore, like to thank everyone involved in the creation of this guide for their diligence and leadership.

Some wait to be regulated before they change, but it is now clear that radical reform is coming. Industry must prepare and should be taking action ahead of legislation coming into force.

Initiatives like this help to boost confidence in what to do and show that the industry is capable of taking responsibility rather than waiting for others to produce guidance. It gives me hope that the culture in construction is changing.

DAME JUDITH HACKITT  
DBE FRENG FICHEME FCGI

“Industry must prepare and should be taking action ahead of legislation coming into force.”

# FOREWORD



## **Since the tragic fire at Grenfell Tower in the summer of 2017, fire safety has become a major industry focus.**

**Service penetrations in fire-separating elements are in part a minor element of a compartment wall or floor, yet in truth they are one of the most important elements when it comes to ensuring the performance of any compartment wall or floor is maintained.**

This importance drove the ASFP, BESA, BSRIA, FIS and GPDA to hold a series of industry-facing workshops to understand why issues keep occurring and what barriers have hindered a collaborative and responsible approach to the design, specification and installation of service penetrations in fire-separating elements.

This guide is the result of a collaborative review from stakeholders in the industry, including manufacturers, designers, contractors and specialist fire companies.

Each project is unique in its requirements, but the aim of this guide is to offer guidance to simplify designs to achieve as many standard approaches as possible. It is not an installation manual but guidance to a good practice approach.

The processes listed in this guide should enable a project team to meet their obligations to deliver a safe and secure project in terms of penetration seals.

There may be processes and details identified that are not normally recognised in the traditional approach to penetration seals, but these have been included to offer a new approach to improve how penetration seals are delivered.

This guide has been published and supported by the industry so that it is freely available, with the aim of ensuring the spread of fire due to inappropriate or poorly installed services penetrations can be eliminated.

**NICK MEAD**  
BSC(HONS), CENG, FCIBSE, FIMECHE, MEI  
SYSTEMS AND ASSURANCE LEAD -  
MEICA SYSTEMS  
LAING O'ROURKE EUROPE

# INTRODUCTION

**Figure 1** Compartment walls and floors between dwellings



## **What is fire compartmentation?**

Fire compartmentation in buildings is generally provided by separating elements such as walls, floors and ceilings. It is designed to protect people in and around the building, including fire and rescue personnel, from the effects of the spread of fire by containing it in the compartment of origin for a specified period of time.

Compartmentation subdivides buildings into areas of manageable risk to provide adequate means of escape and to provide fire separation for adjoining buildings.

Firestopping is required to maintain the specified level of fire compartmentation where services penetrate the compartment walls and floors.

# SCOPE

This best practice guide has been produced to assist in the design, specification and installation of building services penetrations through fire compartment walls and floors in new buildings to ensure that fire compartmentation is maintained. Cavity barriers and linear seals are excluded from the scope of this guide. This guide is based on Building Regulations current in England at the time of writing. However, guidance which is relevant to Scotland, Northern Ireland and Wales is provided in Appendix A.

## 0.1 TARGET AUDIENCE

This guide is aimed at the following audiences:

### Designers

- Architects
- Specifiers
- Consultants
- Fire engineers
- Manufacturers
- Principal designers

### Installers

- Principal contractors (main contractors)
- Specialist penetration seal contractors
- M&E contractors
- Contractors

### Inspectors

- Building control bodies (BCBs)
- Clerks of works
- Site managers
- Supervisors
- Competent persons
- Insurers

### Fire and rescue authorities

### Clients

- Owner occupiers
- Building owners
- Residents

### Insurers

## 0.2 STRUCTURE OF THE GUIDE

The main sections of this guide, 1 to 7, provide guidance on actions that should be carried out during each of the stages 1 to 7 as defined in the RIBA Plan of Work [1](#). These are illustrated below, together with stage 0, which is not covered in this guide as no decisions relating to firestopping are made at this stage.



RIBA  
Plan of Work

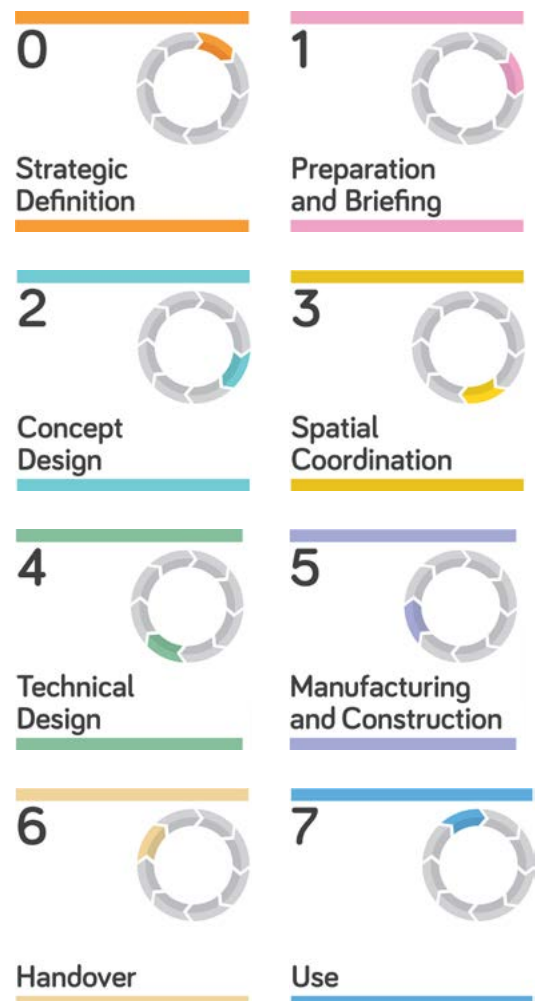

Reproduced courtesy of the  
Royal Institute of British Architects



## THE GOLDEN RULES

The nine Golden Rules (GRs) are referenced at the beginning of sections 1 to 7 of this guide. Penetration seals should ideally be considered at stages 1 and 2, however this will be project dependent and the Golden Rules may not apply until stage 3.

The Golden Rules set out the process from early engagement with manufacturers at the initial design stages through to installation and inspection of penetration seals.

<b>GOLDEN RULE 1</b> Ensure an early engagement with firestopping manufacturers and specialist installers.	<b>GOLDEN RULE 2</b> Review the fire strategy documents and fire strategy plans in conjunction with the M&E specifications.	<b>GOLDEN RULE 3</b> Identify all of the service types passing through the compartment floor or wall including any insulation products. Establish the space required to install and firestop the services.
<b>GOLDEN RULE 4</b> Follow the 'Design process for penetration seals'.	<b>GOLDEN RULE 5</b> Only select firestopping products which are third party certified by a UKAS accredited organisation. Firestopping products should be certified or CE marked and tested using the relevant standards.	<b>GOLDEN RULE 6</b> Ideally select one firestopping manufacturer throughout the project. Products from different manufacturers should not be mixed in the same opening unless there is clear test evidence to substantiate their use.
<b>GOLDEN RULE 7</b> Request copies of the third party certification from the manufacturers. These should be reviewed by a suitably qualified person to ensure the certification and field of application is relevant for the situation.	<b>GOLDEN RULE 8</b> Ensure the installers of ALL service penetration seals are third party certified by an organisation such as FIRAS, LPCB, IFC, BM TRADA etc.	<b>GOLDEN RULE 9</b> Implement a structured inspection plan to include photographic evidence as the work proceeds.

### 0.3 RACI MODEL

Planning and communication is key in the success of any plan to reduce the risk of injury. To assist this, a project planning tool known as the RACI model is recommended:

#### EXAMPLE TASK

Installing the penetration seal

#### WHO IS RESPONSIBLE?

Who is or will be doing this task?

Who is assigned to work on this task?

Third-party certified penetration seals specialist

#### WHO IS ACCOUNTABLE?

Whose head will roll if this goes wrong?

Who has the authority to make decisions?

Third-party certified penetration seals specialist supervisor

#### WHO SHOULD BE CONSULTED?

Is there anyone who can tell me more about this task?

Are there any stakeholders already identified?

Product manufacturer  
Drywall manufacturer  
Designer  
M&E contractor

#### WHO NEEDS TO BE INFORMED?

Is there anyone whose work depends on this task?

Who has to be kept updated?

The principal contractor

#### KEY PERFORMANCE INDICATOR

Compliant penetration seal underpinned with a full documentary record including product certification

## 0.4 TERMS AND DEFINITIONS

For the purposes of this guide, the terms and definitions given in EN 1363-1 and EN ISO 13943 and the following apply.

### **Ablative batt**

A material made from mineral / rock wool with an ablative coating which further improves its fire-resistant properties.

### **Ad hoc testing**

Some penetration seal products may have test evidence created by ad hoc testing to BS 476: 20. The testing is deemed ad hoc because the British Standard BS 476: 20 does not specifically deal with penetration seals.

### **Annular space**

The gap between a centred circular single service and the aperture edge in a circular penetration.

### **Benchmark**

A sample defining the detailing and quality of a penetration seal.

### **Blank penetration seal**

A seal for an aperture through a fire-separating element designed to maintain the fire resistance of a fire-separating element for the duration of the specified fire resistance period without incorporating penetrating services.

### **Board**

A flat panel, manufactured from gypsum, fibre gypsum, GRG, cement or calcium silicate.

### **Building control body (BCB)**

The body responsible for enforcing Building Regulations on a project and assisting with compliance by giving feedback on plans and providing site inspections. This may be a local authority building control officer or an approved inspector.

### **Busbar**

A strip or bar of rigid metal that conducts electricity, either as a single element or within a busbar trunking unit.

### **Cable carrier**

A component of a cable installation system for the continuous support of cables, such as a cable ladder, cable tray or cable basket.

### **CDM Regulations**

Regulations that are intended to protect persons from health and safety risks from construction work through a systematic framework for management of those risks.

### **CE marking**

A method of permanently marking products to demonstrate they meet the performance requirements where a Harmonised European Standard exists in accordance with the Construction Products Regulations.

### **Cold smoke**

Smoke at ambient temperature.

### **Collar**

A pipe closure device incorporating an outer casing which acts as a restraint for an intumescent material, enabling the collar to be either surface fixed to the fire-separating element or incorporated within it.

**Compartment (fire)**

A building or part of a building, comprising one or more rooms, spaces or stories, that is constructed to prevent the spread of fire to or from another part of the same building or an adjoining building.

**Compartmentation**

A means of preventing the spread of fire within a building and providing adequate means of escape by containing it in the compartment of origin.

**Conduit**

A metal or plastic casing designed to accommodate cables, normally circular in section.

**EAD (European Assessment Document)**

Documentation of the methods and criteria accepted in European Organisation for Technical Assessment (EOTA) as being applicable for the assessment of the performance of a construction product in relation to its essential characteristics.

**Fire risk assessment**

A regular undertaking to review the risks to prevent fire and protect occupants in the event of a fire.

**Fire-separating element**

A compartment wall, compartment floor or construction that encloses a protected escape route and / or a place of special fire hazard.

**Firestopping**

See **penetration seal**.

**Flexible construction**

Drylining or horizontal or vertical supporting construction consisting of studs or joists, including linings and optional insulation.

**Flexible partition**

A metal stud drylined partition is defined as a flexible partition in a fire test.

**Intumescent**

A reactive material that, when heated, expands to maintain the penetration seal.

**Label**

A permanent marking next to a penetration providing information about the penetration seal.

**Multiple penetration seal**

A seal intended for penetrations where more than one service of the same type (eg cables or pipes) pass through.

**Passive fire protection**

A product or system that provides protection to the building and occupants without further change or requirement for activation or motion, for example fire resistant drylining.

**Penetration**

An aperture in a fire-separating element with one or more services passing through.

**Penetration seal**

A system used to maintain the fire resistance of a fire-separating element at the position where one or more services pass through or where there is provision for services to pass through a fire-separating element – for the latter see **blank penetration seal** (page 11).

**Pipe closure device**

A reactive device used to seal pipe penetrations, such as a collar, a wrap or a sleeve.

**Plasticisation**

The absorption of small, chemically benign molecules that migrate between the macromolecular chains, thus allowing the plastic part to lose stiffness.

**Rigid construction**

High density constructing element designed from block work, masonry or concrete with an overall density  $\geq 850\text{kg/m}^3$  with a thickness appropriate for the expected fire resistance period or a low density constructing element made from aerated concrete block, masonry or lintels with an overall density of  $650\pm 200\text{kg/m}^3$  with a thickness appropriate for the expected fire resistance period.

**RRFSO**

Regulatory Reform (Fire Safety) Order 2005 a statutory instrument, applicable only in England and Wales. The Order places the responsibility on individuals within an organisation to carry out risk assessments to identify, manage and reduce the risk of fire.

**Service support construction**

Local mechanical support provided in the form of clips, ties, hangers or any device designed to carry the load of the penetrating services. The service support construction does not include cable carriers.

**Single opening**

Is a prepared opening in a separating element (wall or floor) designed for services to pass through. It is a type of a builder's work hole.

**Single service penetration seal**

A seal intended for penetrations with only one service passing through.

**Sleeve**

A pipe closure device that passes completely through the fire-separating element and may include an outer casing.

**Supporting construction**

The wall or floor construction used to support the penetration seal.

**System owner**

Person or organisation who owns the performance evidence of a system.

**Third-party certification**

A conformity assessment process carried out by a body that is independent of both supplier and customer organisations. It provides confirmation that products and services have met and will continue to meet the requirements of specified standards and other normative documents.

**Trunking**

A metal or plastic casing designed to accommodate cables, normally square or rectangular in section. Sometimes 'lidded cable tray' is used synonymously.

**Wrap**

A pipe closure device that is usually wrapped around the pipe, located within the fire-separating element and acts as a restraint for the intumescent material.

# 1 PREPARATION AND BRIEFING

**1**



**Preparation and Briefing**

**GOLDEN RULE 1**

Ensure an early engagement with firestopping manufacturers and specialist installers.

**WHO DOES THIS APPLY TO?**

- Architects
- Consultants
- Manufacturers
- Specifiers
- Fire engineers

## 1.1 DESIGN PROCESS

The project team should start by defining the responsibilities for the project. BSRIA Guide BG 6 [40](#) can be used to define who has which design responsibilities at which stages of the project.

Note: the Construction (Design and Management) Regulations (CDM) will always take precedence.

The nine Golden Rules should be used when considering the mechanical and electrical services penetrations through fire-separating elements to ensure compliant design, selection and installation of penetration seals.

The principal designer under CDM is responsible for ensuring the product specified either initially or through subsequent design changes meets the performance requirements required to comply with the Building Regulations. This may include examining engineering judgements, technical evaluations, certification and test reports.

The Association for Specialist Fire Protection (ASFP) Advisory Note 17 [2](#) and the Passive Fire Protection Federation (PFPF) technical assessment guide [3](#) should be used when designing.

The principal designer holds this responsibility during the pre-construction phase, and responsibility is handed over to the principal contractor once construction starts.

The following factors should be considered as early as possible:

- Number and type of services
- Their configuration
- Minimum distances between services
- Minimum distances between openings
- Future requirements.

If the full extent of the M&E services is not known at the start of the design process, the design should be monitored so information and decisions are recorded and captured at the earliest opportunity to allow for the compliant design and installation of the penetration seals.

When sequencing the work, compartment walls with prepared openings should be programmed ahead of the installation of the M&E services to ensure the compartment wall can be installed compliantly above the services.



**Figure 2** Ensure adequate provision is made to access above and around services to install penetration seals

## 1.2 COLLABORATION

For any penetration seal to be successful, there must be collaboration between all parties with adequate time allowed. This would include:

- Designers: principal designer, architect, structural engineer, building services engineer and specialists such as access consultants and fire engineering consultants
- Building control bodies
- The principal contractor
- Specialist penetration seal contractors
- M&E contractors
- Product manufacturers – penetration seals, drylining, M&E services
- The building owner.

## 1.3 RESPONSIBILITY

Everybody involved in provision of a fire protection package, at any level, shares liability for its effectiveness and performance when needed in a fire.

For more detailed information, see the ASFP advice [Fire and your legal liability](#) **4**

Anybody making product decisions at any point should be aware that they are

taking on a level of design responsibility and potentially a consequent liability. Under CDM, a designer is an organisation or individual whose work involves preparing or modifying designs for construction projects, or arranging for, or instructing, others to do this.

## COMPETENCY

- 1.4** A Skills, Attitude, Knowledge and Experience (SAKE) approach is being developed in response to the government's review of the Building Regulations and will be assessed by manufacturers for each stage of the RIBA Plan of Work.

The definition of competency can be defined as someone with the skills, knowledge and experience to carry out the task. However, a key component is also how they approach their work and the attitude to ensuring that the task is always carried out to the best of their ability.

More information about SAKE can be found in Annex D of Appendix A to the [Raising the Bar Interim Report](#) **5**

The PFPF Technical Assessment Guide **3** provides guidance on the competency requirements of assessors and reviewers. The guide recommends that the assessment is performed by an assessor with the appropriate level of expertise from the competency matrix of the relevant organisation.

# 2 CONCEPT DESIGN

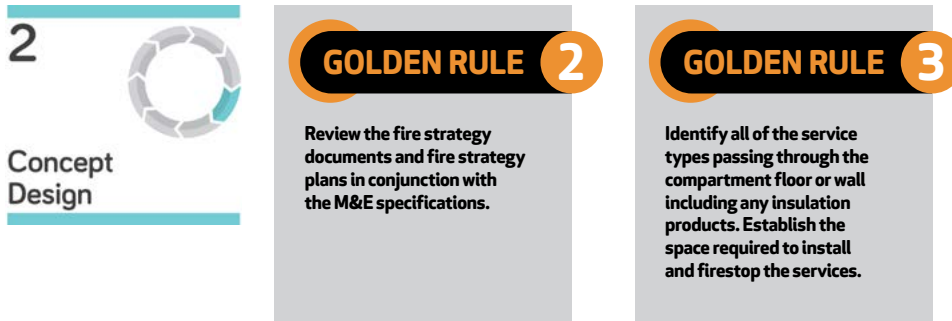

**WHO DOES THIS APPLY TO?**

- Architects
- Consultants
- Manufacturers
- Specifiers
- Fire engineers
- Specialist installers

## 2.1 BUILDING FIRE STRATEGY

A fire strategy provides a clear set of measures encompassing fire precautions, management of fire safety and fire protection.

The common approach for producing a fire strategy is using Approved Document B Volume 1 [6](#) (for dwellings) or Volume 2 [7](#) (for non-dwellings) or BS 9991 [37](#) and BS 9999 [36](#)

Approved Document B provides guidance on achieving the functional requirements of the Building Regulations for simple buildings. However, it can be restrictive in some complex buildings.

Fire engineering using BS 7974 [8](#) can offer flexibility and innovation to explore the various design solutions available within the project.

A fire strategy, in conjunction with drawings and / or a digital model, should explicitly detail the type of fire safety facilities that are to be incorporated within the building, along with their respective specifications.

The fire strategy will contain information on compartmentation and the requirements for any passive fire protection. This should include basic

details of the requirements for the penetration seals. The section on penetration seals should be read and understood by the designer, contractor, installers and checkers of the penetration seals to ensure they are compliantly designed and installed. If there is any doubt, the fire engineer should be consulted at the earliest opportunity.

It is essential that designers, contractors and all those involved in a project read and understand the fire strategy document and / or fire strategy drawings.

Where a fire engineer is appointed as part of the design team, they become responsible for writing a fire strategy to comply with the Building Regulations.

Designers should ensure that a project complies with the current published guidance (eg Approved Document B or BS 9999) and / or meets the functional objectives of Schedule 1 of the Building Regulations through the development of an alternative fire engineering approach.

Information about Part B of the Building Regulations can be found in Appendix A1 of this guide.



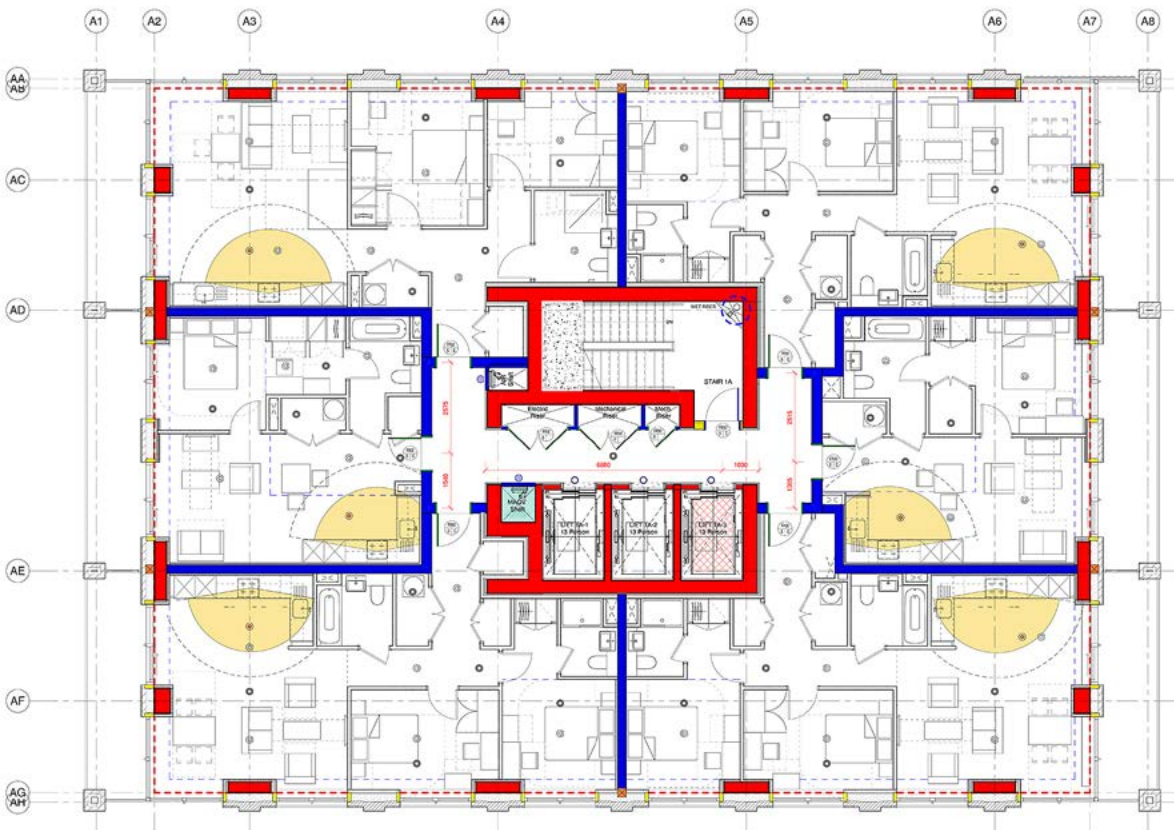

**Figure 3 Typical fire strategy plan with coloured compartment walls illustrating the fire ratings required (image courtesy of Broadway Malyan)**

Throughout the RIBA Plan of Work stages 2 and 3, a fire engineer should be retained to assist the design team, lessen the project fire risks and ensure successful coordination with the Building Control Body and fire authority throughout the rest of the project.

## 2.2 COMPETENCY TO PREPARE A FIRE STRATEGY

It is vital that those entrusted to prepare a fire strategy have the necessary levels of competence to undertake the task professionally and thoroughly. The level of competency required will be commensurate with the expected complexity of the building to be assessed, but the person or team should have the following credentials:

- A good understanding of fire-related aspects of premises and their function
- An appropriate knowledge of fire legislation and the requirements of other enforcing bodies
- Appropriate qualifications, training and / or experience in fire safety and fire protection issues
- Knowledge of relevant national codes and past experience of their application.

One way of validating competency is to ensure that those preparing the strategy or those approving the strategy are members of a relevant professional body at an appropriate level.

For more detailed studies, the competent person or company may need to demonstrate ability to undertake complex fire modelling or evacuation analysis.

## 2.3 MECHANICAL AND ELECTRICAL (M&E) STRATEGY

Penetration seals should be considered during the M&E design phase, so that the correct and compliant penetration seals can be specified.

Consulting engineers should consider penetration seals and not rely on the Contractor's Designed Portion (CDP) element. This is to avoid the design of the penetration seal being considered too late.

The M&E strategy should follow the design processes for penetration seals given in section 3 of this guide.

The sequencing of the installation of the M&E services and penetration seals should be designed to ensure that there is sufficient access to install and maintain the services and penetration seals.

## 2.4 THE SERVICES SHOULD BE DESIGNED IN CONJUNCTION WITH THE PENETRATION SEALS SO THEY ALLOW FOR A COMPLIANT INSTALLATION

Note: penetration seals are not normally tested for the resistance to passage of smoke and toxic gases and this is not defined in the test standards (BS476 and BS EN 1366-3). However, air pressure testing (using methods and standards described in approved document L) can be used to satisfy cold smoke / toxic gas performance. Where there is a secondary compartment, the air pressure testing data may be used for ambient smoke resistance.

Note: where ventilation ductwork is specified, consideration should be given to whether fire risk is from outside of the duct (Duct A) or inside the duct (Duct B) as

defined in BS EN 1366-1 [11](#). Also, consideration should be given to the penetration seal around the duct.

The installation of all the penetration seals should be awarded to a specialist contractor with third-party certification.

## 2.5 MODULAR M&E INSTALLATION

Modular M&E installation ranges from small service modules to complete building modules. Two common types are discussed below.

### 2.5.1 PREFABRICATED MODULES



Figure 4 Example of a prefabricated corridor M&E module

Components and equipment are integrated into sub-assemblies off site and then installed on site.

These modules can take the form of bathroom pods or M&E modules, corridor modules (an example of which is illustrated in figure 4), riser modules, machine racks and plant rooms. It may be possible to install the penetration seals into these modules in a factory. However, this would need to be reviewed with the firestopping manufacturers.

There are a number of manufacturers who are developing modular construction methods for penetration seals within a framework assembled off site, containing small sections of the services (spool pieces) pre-installed and the penetration seals completed around the services and the frame.

Factory assembly can provide better access to the penetration seals, allowing easier installation and inspection. The factory installation should still be carried out by a third-party certified penetration seal installer.

The early involvement of M&E consultants, contractors and specialist penetration seal system owners will assist in coordinating how the penetration seals can be integrated into the M&E design.

Note: any certification given to the firestopping in the factory would need to be reviewed when the modules are installed in site conditions. There can be damage to the penetration seals in transportation and this should be checked.

## **2.5.2 MODULAR BUILDING CONSTRUCTION**

As modular construction methods are developed, the approach to pre-assembled service penetration seals may become more commonplace.

When penetration seals are used for service penetrations in modular buildings, the products used may also be required to provide fire protection to the building structure in addition to the fire compartment requirements for the walls and ceilings. The penetration seal products selected would not normally be tested for loadbearing constructions. A specialist should be consulted as the penetration seals may need to be tested for this application. If the penetration seals are

pre-installed in the factory, these can be vulnerable to damage in transportation and should be checked.

Some prefabricated modular construction systems may require further penetration seals after installation.

## **2.6 PROVISION TO INSTALL ADDITIONAL SERVICES - FUTURE PROOFING**

During the lifecycle of a building it may be necessary to install additional services through existing penetration seals and this can compromise their performance.

Where additional services are likely to be installed on a regular basis, designers should consider using proprietary products for this purpose which allow removal and addition of services without damaging the penetration seal.

# 3 SPATIAL COORDINATION

**3**



Spatial Coordination

**GOLDEN RULE 4**

Follow the 'Design process for penetration seals'.

**WHO DOES THIS APPLY TO?**

- Designers
- Contractors
- Manufacturers
- Installers
- Fire and rescue authorities

## 3.1 DESIGN PROCESS FOR PENETRATION SEALS

This section of the guide should be used for the design process of penetration seals within fire-separating elements to comply with the Building Regulations.

Note: penetration seals through cavity barriers are not included in this guidance. Refer to the relevant sections in Approved Document B **6 7** for guidance on this topic.

Penetration seals should be designed to ensure they can adequately accommodate the required number and type of services.

Each penetration seal or blank penetration seal should be given a unique reference number, and these should be logged with details of the penetration seal, the finished size and construction details.

In order to ensure the correct type of penetration seal is specified and installed, there are several key questions that need to be addressed before a final selection can be made.

These include, but may not be limited to:

### SUPPORTING CONSTRUCTION QUESTIONS

- Are the penetration seals used in a wall or a floor?
- What type of supporting construction is being used?
- What fire resistance period does the supporting construction have?
- What test standards are to be used in the compartmentation?
- Is the supporting construction required to have a particular reaction to fire performance? Does this requirement also apply to any penetration seal?
- Is the seal required to have acoustic, airtightness or water resistance properties? Does this requirement also apply to any penetration seal?
- Is there a requirement to frame out the penetration in the drylining?

### PENETRATION QUESTIONS

- What size is the penetration seal?
- How close is the penetration to other penetrations in the same supporting construction?
- If it is a floor, is it required to be loadbearing in a non-fire situation?

## **PENETRATION SERVICE QUESTIONS**

- What kind and type of penetration services, if any, are passing through the penetration?
  - How many penetrating services are there?
  - What size is each penetration service?
  - How close are the services positioned to each other?
  - What are the edge distances between the penetration service and the supporting construction?
  - Is the penetration seal suitable for use with the intended supporting construction?
  - Is the penetration passing through a one-sided flexible wall construction (shaftwall and some independent wall linings)?
  - Is the installation accessible for the particular type of service and penetration seals being considered?
  - If in contact with live electrical services, is there a requirement for particular electrical insulation characteristics?
  - Do the penetration seals have to cater for movement?
  - What insulation types are installed around the services?
  - Has the pipe penetration been tested under the relevant end conditions?
  - Will penetration seals be accessible from one side or both during installation?
  - What are the diameters of the pipe sizes?
  - Have the types of plastic pipes been considered?
  - Are there any partial penetrations?
  - Do any openings carry more than one type of service?
  - Can standard solutions be designed?
- What is the design life?
  - Is access provided for inspection and maintenance of penetration seals?
  - What are the limitations of the selected service penetration seal?
  - Are CPVC services used?
  - Are there any short metal pipes (spools) to be connected later in the programme?
  - Are there any busbars?

These questions are addressed in sections 3.1.1 to 3.1.34 of this guide.

All penetration seals should be firestopped with proprietary penetration seal products irrespective of size.

### 3.1.1 ARE THE PENETRATION SEALS USED IN A WALL OR A FLOOR?

Penetration seals are designed to be suitable for specific interfaces with fire-separating elements such as floors, walls and soffits.

The intended use and interface with other elements of the fire separating construction should be checked against the third party certification before selection and installation.

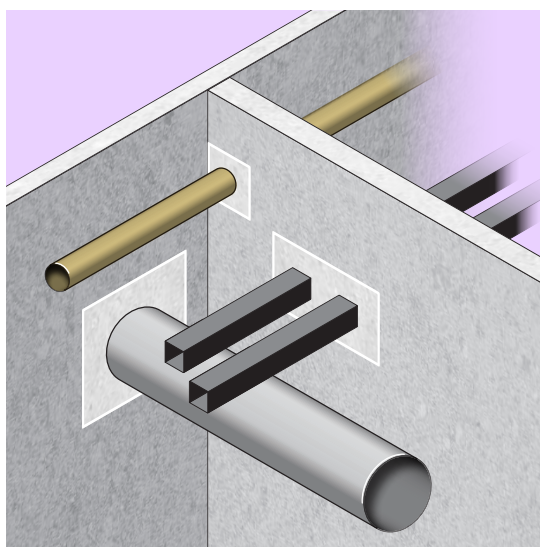

Figure 5 Location of the penetration seals.

### WHAT TYPE OF SUPPORTING CONSTRUCTION IS BEING USED?

3.1.2 The penetration seal should only be installed in the supporting substrate covered by the third-party certification. For example, timber, masonry and drylining substrates will each perform differently in a fire and this will inform the type of penetration seals to be installed (see figure 6).

### 3.1.3 WHAT FIRE RESISTANCE PERIOD DOES THE SUPPORTING CONSTRUCTION HAVE?

The following text is extracted from clause B19 of Approved Document B 6 7:

*Fire resistance is a measure of one or more of the following:*

- Resistance to collapse (loadbearing capacity), which applies to loadbearing elements only, denoted R in the European classification of the resistance to fire performance.*
- Resistance to fire penetration (integrity), denoted E in the European classification of the resistance to fire performance.*
- Resistance to the transfer of excessive heat (insulation), denoted I in the European classification of the fire resistance to fire performance.*

These are classified under BS EN 13501-2 14

#### **Integrity only**

15min	E15
20 min	E20
30 min (half hour)	E30
60 min (one hour)	E60
90 min (one and a half hour)	E90
120min (two hour)	E120
180min (three hour)	E180
240min (four hour)	E240

#### **Integrity and Insulation**

15 min	EI15
20 min	EI20
30 min (half hour)	EI30
60 min (one hour)	EI60
90 min (one and a half hour)	EI90
120min (two hour)	EI120
180 min (three hour)	EI180
240min (four hour)	EI240

Figure 6 Examples of supporting construction



Cross laminated timber (CLT) wall

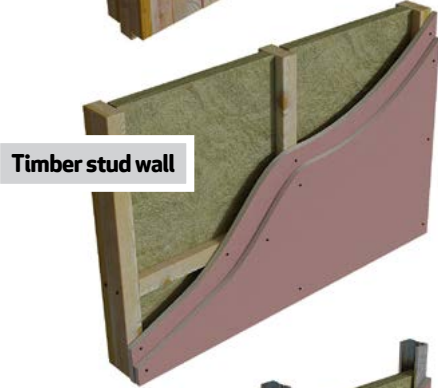

Timber stud wall

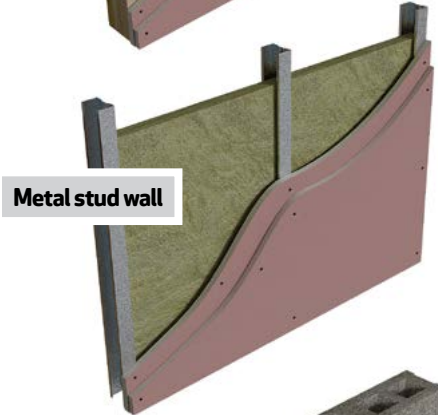

Metal stud wall



Hollow masonry wall

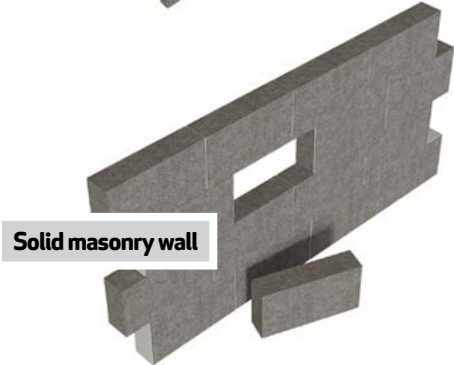

Solid masonry wall



Timber joisted floor



Cross laminated timber (CLT) floor



Steel reinforced concrete floor

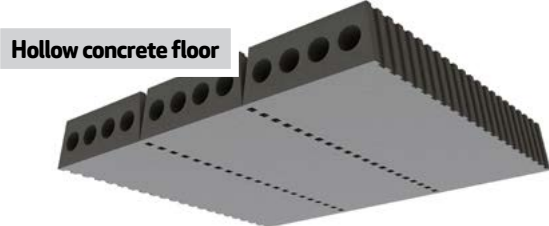

Hollow concrete floor



Corrugated steel reinforced concrete floor

The E and I ratings necessary to provide the required fire resistance for the elements of structure and compartmentation are given in Approved Document B. The penetration seals should comply with these requirements and be defined as integrity (E) and insulation (I).

Note: it is not always possible to achieve insulation (I) in all penetration seals and therefore consultation should be made with the design team.

The BS 476 series of standards [15](#) can be used to meet the guidance within Approved Document B. However, it should be noted that integrity and insulation (E / I) cannot be referred to using these standards.

### 3.1.4 WHAT TEST STANDARDS ARE USED IN THE COMPARTMENTATION?

The test standards currently available for the testing of penetration seals are either the BS EN 1366 series [10](#) or the BS 476 series [15](#)

For example:

- BS EN 1366-3 [12](#) specifies a method of test and criteria for the evaluation (including field of application rules) of the ability of a cable or pipe penetration seal to maintain the fire resistance of a fire-separating element at the position at which it has been penetrated by a service
- BS 476-20 [16](#) provides methods for determination of the fire resistance of elements of construction (general principles). This is an ad hoc approach and there are no specific test criteria set down for penetration seals.

Where it is possible, BS EN 1366 test standards should be used to select penetration seals.

### 3.1.5 IS THE SUPPORTING CONSTRUCTION REQUIRED TO HAVE A PARTICULAR REACTION TO FIRE PERFORMANCE? DOES THIS REQUIREMENT ALSO APPLY TO ANY PENETRATION SEAL?

Fire resistance and reaction to fire are separate measures of fire performance and there is often confusion between the two.

Fire resistance is the measurement of the ability of a material or system to resist, for the period of required fire performance, the passage of fire and heat from one distinct area to another.

Reaction to fire is the measurement of how a material or system will contribute to the fire development and spread, particularly in the very early stages of a fire when evacuation is crucial. Reaction to fire is classified under BS EN 13501-1 [13](#). The elements of this classification are illustrated in figure 7.

- The first letter gives a classification based on the combustibility and contribution to fire: A1 and A2 is non-combustible; B to D go from very limited to medium contribution to fire; and E and F go from high contribution to easily flammable.
- The 's' part relates to the total smoke propagation / emission level. The values range from 1 (absent / weak) to 3 (high).
- The 'd' part indicates the 'flaming droplets and particles' during the first 10 minutes of exposure.

Note: only s3 d2 is applicable in England as there is no requirement to specifically control s or d.

Note: it is commonly assumed that if pipe lagging is classified as 13501 B (previously known as Class 0 in the UK) it is fire resistant, but it is not. This classification is a reaction to fire performance and the insulation could be combustible – for example, phenolic insulation.



Note: the classifications for reaction to fire in table 1 (see page 37) use the European classification system set out in BS EN 13501-1. However, there may be some products lawfully on the market using the national classification. National classifications do not automatically equate with the equivalent European classifications and therefore products cannot assume a European classification unless they have been tested accordingly.

## B s1, d0

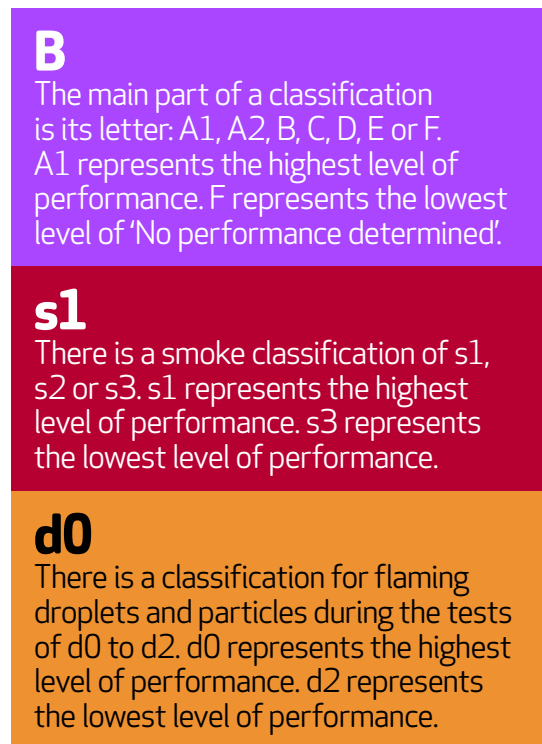

Figure 7 Fire reaction key to types

### 3.1.6 IS THE SEAL REQUIRED TO HAVE ACOUSTIC, AIR TIGHTNESS OR WATER RESISTANCE PROPERTIES? DOES THIS REQUIREMENT ALSO APPLY TO ANY PENETRATION SEAL?

In addition to fire performance, penetration seals may be required to provide other properties, which can include:

- Acoustic performance
- Airtightness
- Air pressure
- Water resistance
- Smoke seals
- Aesthetic requirements.

The additional performance requirements should be reviewed with the system manufacturer at the earliest opportunity to ensure that adequate provision is made to accommodate the project-specific requirements.

Where there are service penetrations through a wall or floor, the overall acoustic performance will be affected by the number and size of penetration seals and the type used. Maintaining the acoustic performance of a wall or floor may not be achievable with the firestopping alone. The acoustic requirements should be discussed with the project acoustician and coordinated with the penetration seal manufacturer.

Note: penetration seals should be suitable for use in the intended application and environment, for example swimming pools. These additional characteristics for penetration seals can be demonstrated by following the testing protocol in the EAD (European Assessment Document).

### 3.1.7 PROVISION TO FRAME OUT (REINFORCE, SUPPORT) PENETRATIONS IN DRYLINING

Some penetration seal products are tested in openings formed within drylining with no support framework for the board at the service opening (see figure 9).

Whilst this method can achieve the required fire performance as tested by the penetration seal manufacturer, this methodology may not be covered by the drylining system manufacturer's recommendations who require the penetration to be lined to maintain the performance of their partition elements and this should be checked (see figure 8).

Clauses 9.25 of Approved Document B Volume 1 [6](#) and 10.25 of Approved Document B Volume 2 [7](#) states:

*Materials used for firestopping should be reinforced with (or supported by) materials rated class A2-s3, d2 or better to prevent displacement in both of the following cases:*

- a) *Where the unsupported span of the penetration is greater than 100mm.*
- b) *Where non-rigid materials are used (unless subjected to appropriate fire resistance testing to show their suitability).*

Designers should consult with the drylining manufacturer or system owner to establish a compliant design for the drylining. ASFP Guidance note 10 provides further information [18](#)

### 3.1.8 WHAT SIZE IS THE PENETRATION SEAL?

The penetration seal manufacturer's third-party certified field of application and / or third-party certification report should be checked to confirm the maximum size of opening into which the penetration seal can be installed.

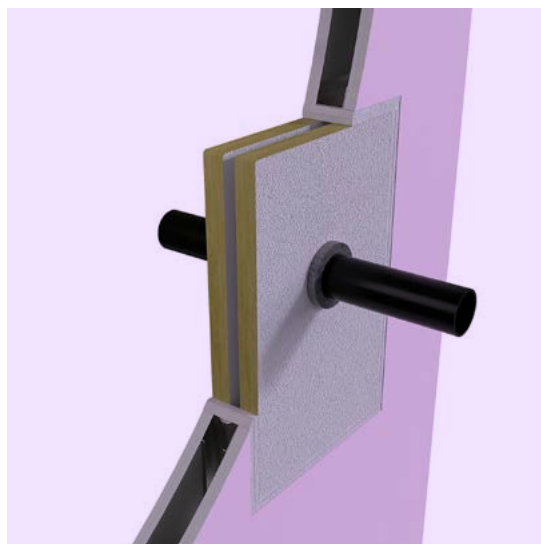

**Figure 8 Framing out and board lining of services openings in drylined partitions**



**Figure 9 Unframed opening in drylining**

The supporting construction should be checked to ensure it is capable of forming the size and location of penetration seal required.

The penetration seal manufacturer should be consulted to ensure they have suitable evidence to cover this application.

Where the parameters of the design fall outside of the test evidence, the designer should have a field of application (FOA) report produced, which will outline variations and permitted parameters.

The FOA report should be produced by a competent person who will bring together numerous BS EN standards and fire test reports into a single document.

In the case of drylined walls, the drylining system provider should be consulted to



**Figure 10 Prepared openings in a drylined partition (note spacings between openings may differ)**

establish the maximum size of the services openings permitted within their system to maintain stated structural / fire performance of the system.

Note that recommendations may vary from one drylining system provider to another.

Where there is a conflict between the guidance from the drylining and penetration seals system providers, both providers should be consulted to ensure the required fire performance is provided.

### **3.1.9 HOW CLOSE IS THE PENETRATION TO OTHER PENETRATIONS IN THE SAME SUPPORTING CONSTRUCTION?**

The penetration seal manufacturer's third-party certified field of application and / or third-party certification report should be checked to confirm the distance required between the penetration seals.

It should be checked that the supporting construction is capable of accommodating the size and location of the penetration seal required.

Where there are multiple services within a flexible partition, it is recommended that the drylining system owner is consulted to ensure that the required minimum distances is achieved between adjacent services openings.

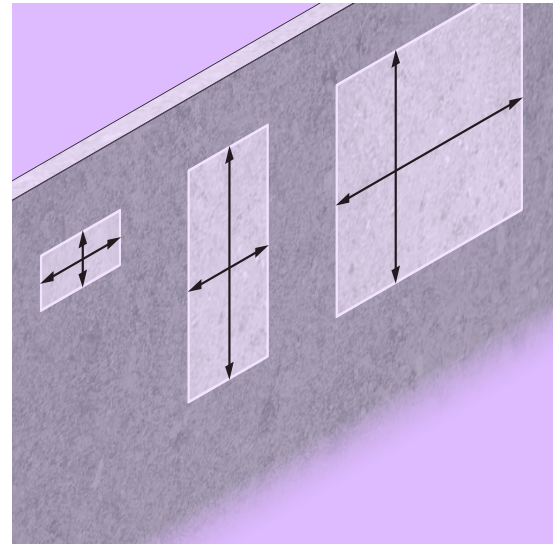

**Figure 11 Size of the penetration seals**

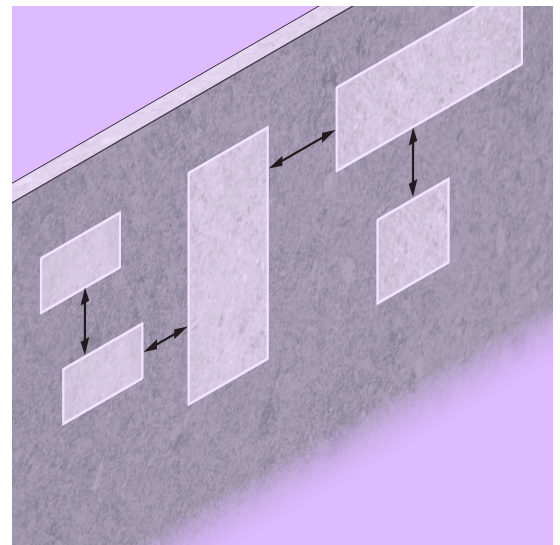

**Figure 12 Proximity of penetration seals**

Note that recommendations may vary from one drylining system owner to another.

The location of the services openings should avoid the door jamb studs.

Where there is a conflict between the guidance from the drylining and penetration seals system providers, both providers should be consulted to ensure the required fire performance is provided.

### 3.1.10 IF IT IS A FLOOR, IS IT REQUIRED TO BE LOADBEARING IN A NON-FIRE SITUATION?

Where there is to be an applied load to the penetration seals, it will influence the choice of penetration seals. For example, ablative batt will not be loadbearing unless additional loadbearing measures are in place, whereas some fire compounds can be used in loadbearing locations in a cold state.

The ASFP provides more guidance in Advisory Note 1 'Safe use of Horizontal firestopping' [42](#)

Note: where the penetration seals are loadbearing, this applies in the cold state only. They are not designed to carry any load in a fire situation. An example of where this is an important consideration is a riser cupboard used to store materials.

Where penetration seals are used within riser cupboards, a notice should be prominently placed warning that 'no goods or materials should be stored on the penetration seal'.

### 3.1.11 WHAT KIND AND TYPE OF PENETRATION SERVICES, IF ANY, ARE PASSING THROUGH THE PENETRATION?

Penetration seals must have been tested and be compliant to be used with the particular M&E service.

The following list gives examples of M&E services and is not exhaustive:

- Combustible pipes
- Non-combustible pipes
- Insulated pipes
- Fire / smoke dampers
- Cable trays
- Cable trunking
- Loose cables
- Conduits
- Back boxes (partial penetrations)
- Busbars

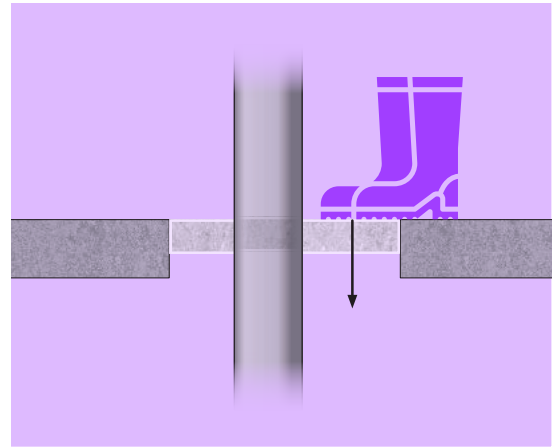

Figure 12 Loadbearing requirements

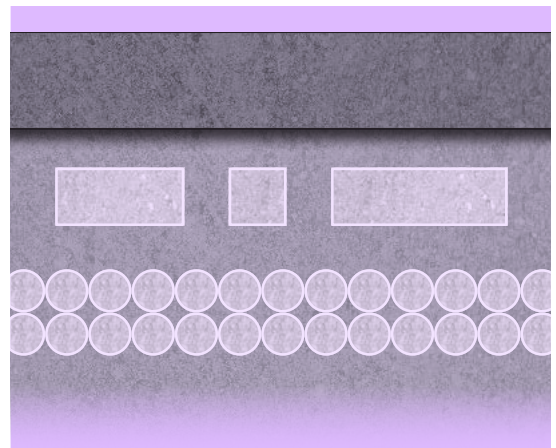

Figure 13 Multiple services

Note: the penetration seals may not be compatible with all products. For example, certain sealants can cause issues with CPVC pipework, which may cause failures of the pipe caused by plasticisation (see section 3.1.32).

### 3.1.12 HOW MANY PENETRATING SERVICES ARE THERE?

The selection of penetration seals for single penetrations may differ from the selection of penetration seals for multiple services in the same penetration.

Designers should consult with the penetration seal manufacturers and the data contained within the third-party certification.

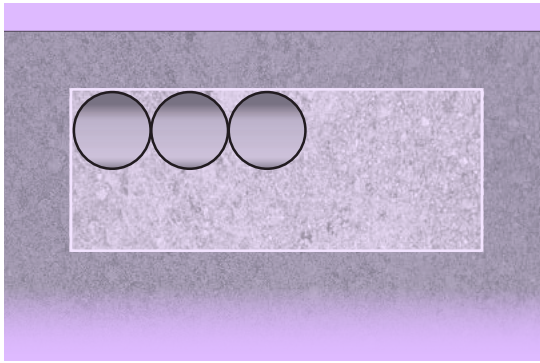

**Figure 15 Proximity of services**

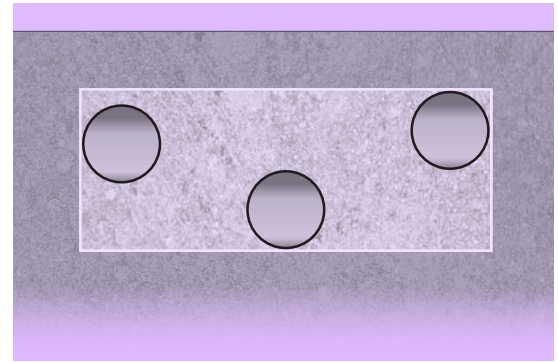

**Figure 16 Edge distances**

### 3.1.13 WHAT SIZE IS EACH PENETRATION SERVICE?

The size of the services will influence the choice of penetration seals and the installation methodology. The fire testing standards may not cover the actual size of the services to be installed. This will need to be reviewed with the project fire engineer and Building Control Body and could require additional fire testing to be carried out. The maximum size of services that are allowed by the scope of third-party certification should be checked.

The following will have implications on the choice of penetration seals:

- What wall thickness and diameter are the pipes?
- What materials are the penetration services manufactured from?
- Does the service penetration have added insulation? And if so, what is the added insulation material type, thickness and installation method?

The penetration seal manufacturer should be consulted to understand any limitations in the tested service sizes.

### 3.1.14 HOW CLOSE ARE THE SERVICES POSITIONED TO EACH OTHER?

The designers should consider the positioning of the services in relation to the penetration seal using the penetration seal manufacturer's data contained within the third-party certification. This will allow sufficient space to install the penetration seals compliantly.

### 3.1.15 WHAT ARE THE EDGE DISTANCES BETWEEN THE PENETRATION SERVICE AND THE SUPPORTING CONSTRUCTION?

The designers should consider the positioning of the services in relation to the penetration seal using the penetration seal manufacturer's data contained within the third-party certification. This will allow sufficient space to install the penetration seals compliantly.

### 3.1.16 IS THE PENETRATION SEAL SUITABLE FOR USE WITH THE INTENDED SUPPORTING CONSTRUCTION?

The information below is relevant to pipe and cable penetrations and is taken from ASFP Advisory Note 15 [9](#)

*In reality, a wide variety of different wall constructions are used on site. It is not practical to test the identical firestopping specification in conjunction with all possible wall constructions. This guidance document has been produced to clarify the rules provided in BS EN 1366-3 [12](#)*

#### **Regulation / requirements**

*Wall constructions are tested in accordance with BS EN 1364-1 and then classified for fire resistance in accordance with BS EN 13501-2. The classifications consider the performance of a wall, integrity and insulation in a fire situation.*

To adopt this approach, firestop systems must be tested in accordance with BS EN 1366-3, and then classified according to BS EN 13501-2 [14](#)

The overall fire performance classification of the compartmentation is limited by the lowest classification of the wall and / or the penetration seal / linear gap seal. Test results obtained with the standard flexible wall constructions, according to BS EN 1366-3, cover flexible wall constructions of equal or lesser fire resistance classification, provided the walls conform with the guidance given in table 1 of this document (see page 37).

### **ASFP guidance**

In order to offer guidance as to areas where differences are allowed between the tested wall system and the constructed wall, the ASFP has produced the following notes and table in figures 17 and 18 indicating typical permitted and prohibited substitutions as defined in BS EN 1366-3.

### **Guidance notes**

The supporting construction shall have an overall thickness not less than the minimum thickness tested and certificated. For advice regarding the positioning of installed intumescent closing devices, consult BS EN 1366-3.

Non-symmetrical wall constructions can be tested, provided they are tested with exposure from both sides, and meet the minimum thickness requirement. However, non-symmetrical walls can be used in practice, based on symmetrical wall testing, provided the asymmetry is an addition to the tested wall without any reduction in the thickness / geometry of the tested components.

In the case of penetration seals installed within the wall, and where a flexible wall with insulation was used in the test, an aperture framing shall be used in practice. The aperture frame and aperture lining shall be made from studs and boards of the same specification as those used in the wall in practice. The thickness of the aperture lining shall be minimum 12.5mm. The number of board layers and the overall board layer thickness is equal or greater than that tested when no aperture framing is used. When a minimum 12.5mm aperture lining is used, board layer thickness may be reduced, provided the overall wall thickness is equal to or greater than that tested.

An aperture framing is considered as being part of the penetration seal. Tests without an aperture framing will cover applications with aperture framing but not vice versa.

Guidance for flexible wall constructions with timber studs can be found within BS EN 1366-3.

The figures below provide guidance but are not all-encompassing. In case of other wall constructions, consult BS EN 1366-3 as appropriate.

ASFP further recommends that any firestopping products be third-party certificated as fit for purpose and installed by third-party certificated installers operating under a UKAS-accredited third-party certification scheme for contractors.

Note: a symmetrical wall, say a standard drywall can have an additional board on one side to make it asymmetrical.

However, an asymmetrical wall such as a shaft wall must be tested from each face.

Note: where timber studs are mentioned in the above guidance this is non-loadbearing.

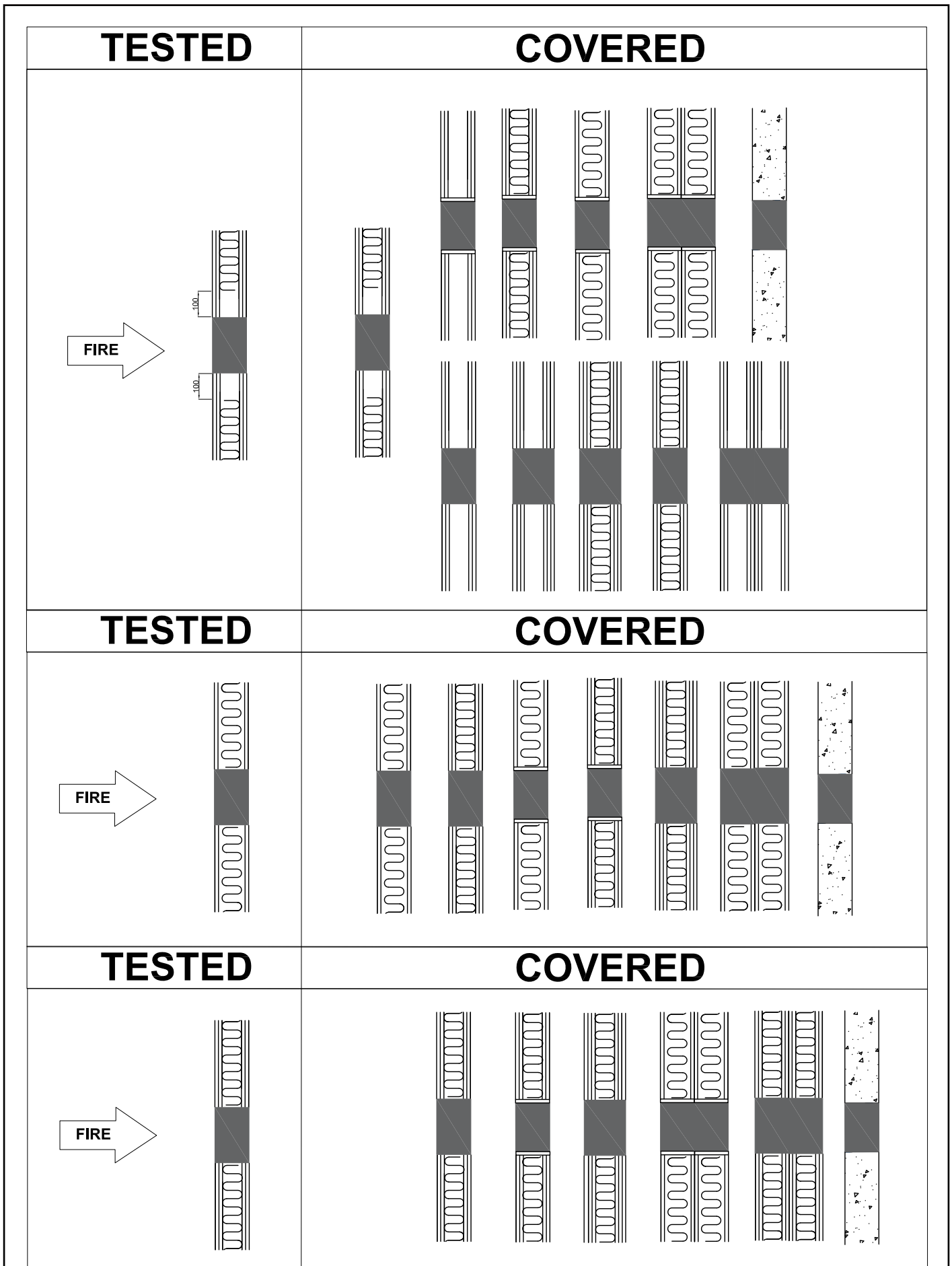

Figure 17 Permitted and prohibited wall construction solutions from ASFP Advisory Note 15

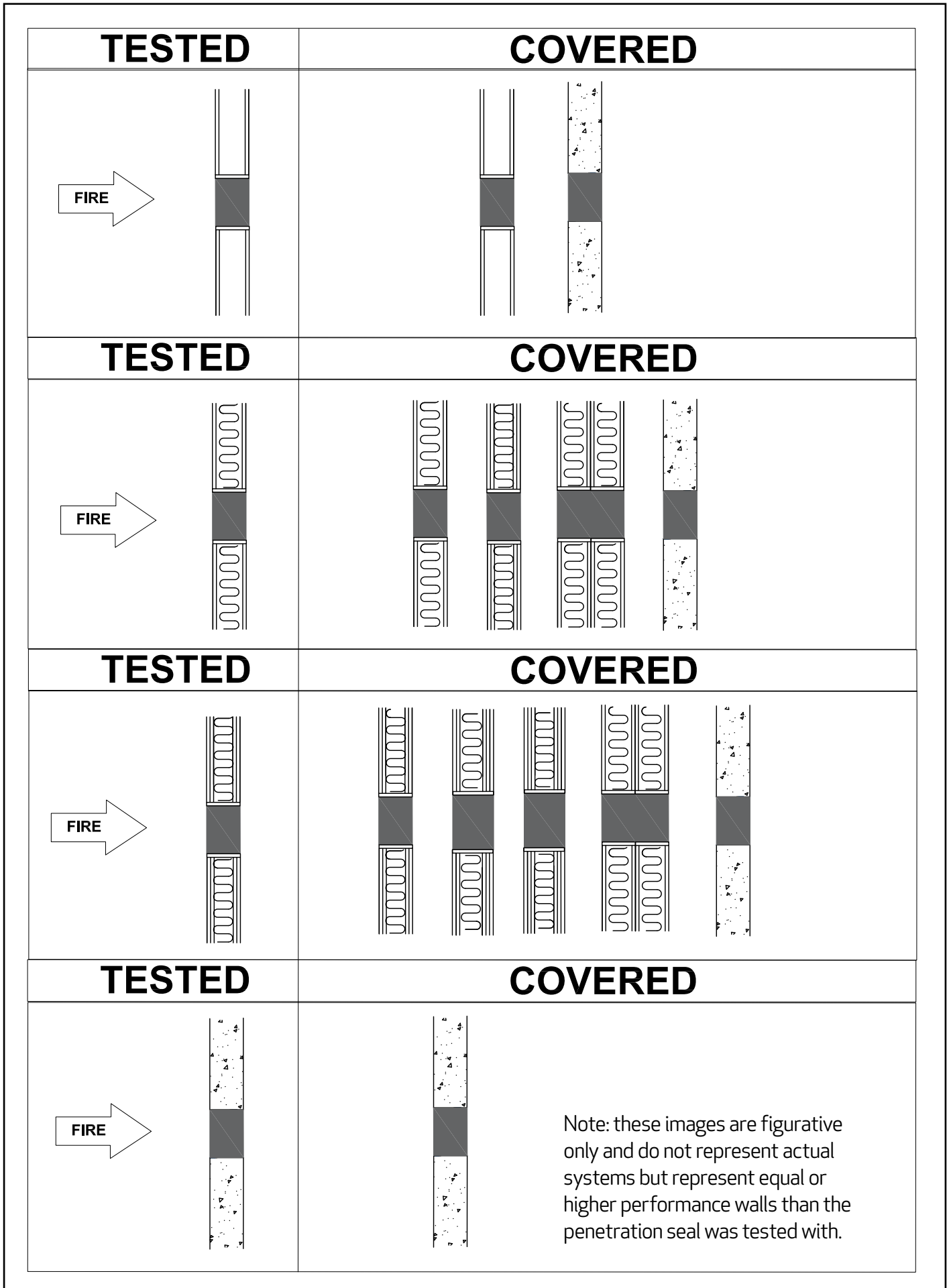
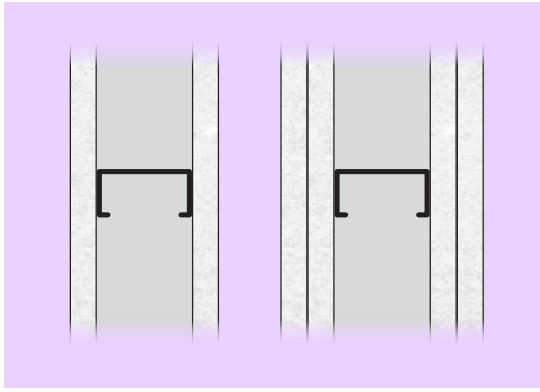

Figure 18 Permitted and prohibited wall construction solutions from ASFP Advisory Note 15





**Figure 19 Drylining construction with either single or double boards each side.**

Flexible (drylining) partitioning – designers should check the certification to establish whether the test has been carried out in a single- or double-boarded installation and satisfy themselves that there is compliant evidence for the proposed solutions. Also, the thickness of the board will be relevant. More guidance on this issue can be found in ASFP Advisory Note 15 <sup>9</sup>

Penetration seals may have been tested in double-boarded constructions and a single layer of board may not be sufficient to support them.

### 3.1.17 IS THE PENETRATION PASSING THROUGH A ONE-SIDED FLEXIBLE WALL CONSTRUCTION (SHAFT WALL AND SOME INDEPENDENT WALL LININGS)

Test results for the penetration seal obtained with the standard one-sided flexible wall constructions in accordance with provisions given in BS EN 1363-1 <sup>10</sup> and BS EN 13501-1 <sup>13</sup> cover all one-sided flexible wall constructions (with and without insulation) of the same fire resistance or higher classification, provided that:

- The construction is classified in accordance with BS EN 13501-2 <sup>14</sup>
- The overall board layer thickness is equal to or greater than that tested
- The number of layers of the wall is equal to or greater than that tested
- The distance between the stud centres is equal to or smaller than that tested

- The depth of the studs is equal to or greater than that tested
- The penetration seal has been tested from both sides.

Any penetration framing or cavity closing used in the test is considered as being part of the penetration seal and must be used in practice. Tests without penetration framing relate to applications with aperture framing (made of materials in accordance with provisions given in BS EN 1363-1 and BS EN 13501-1) but not vice versa.



**Figure 20 Multiple services within a single aperture. Lower services limit the access to the upper penetration seals**

### 3.1.18 IS THE INSTALLATION ACCESSIBLE FOR THE PARTICULAR TYPE OF SERVICE AND PENETRATION SEALS BEING CONSIDERED?

When designing the M&E services and the penetration seals, designers should check that there is sufficient access to carry out the works safely and compliantly.

In addition to the access required to install the penetration seals, there may also be a requirement for access for fire damper inspection and testing. The design should allow for this access.



**Figure 21 Multiple services within a single opening**

Some damper manufacturers make smaller dampers with the added facility to regularly externally test them and reset them. This reduces the requirement for additional access panels or other methods to access the damper.

BESA technical bulletin VH001 <sup>19</sup> provides additional information on maintenance of fire and smoke dampers. Maintenance and inspection of penetration seals should be considered in the design process. Access could be provided by dedicated access panels or by removing ceiling tiles. Guidance on maintenance and access into suspended ceilings is provided in an FIS Best Practice Guide <sup>20</sup>

### **3.1.19 IF IN CONTACT WITH ELECTRICAL SERVICES, IS THERE A REQUIREMENT FOR PARTICULAR ELECTRICAL INSULATION CHARACTERISTICS?**

Where the penetration seal is in direct contact with electrical services such as putty pads, the designers should check with the penetration seal manufacturer and M&E consultants whether the penetration seals need to provide electrical insulation.

### **3.1.20 DO THE PENETRATION SEALS HAVE TO CATER FOR MOVEMENT?**

There are numerous movements and deflections in buildings, for example deflection of the structure as a result of wind, and movement of services due to thermal expansion and contraction. These can have a bearing on the penetration seals, so they should be considered when designing the penetration seals.

The penetration seal may need to accommodate movement of the supporting construction or of the penetrating services. The relative movement may be lateral, rotational or shear.

- Within the supporting construction
- Service movement
- Head deflection
- Shear, compression, extension, rotational
- Wind loading.

The services may move as the building deflects, or they move because of thermal expansion / contraction, and this should be accommodated by the service penetration seals.

It may be necessary to incorporate sleeving to services to allow for movement and this should be checked with the penetration seal manufacturers to ensure that this is allowable within their third-party certification.

Currently there is no test standard that covers this phenomenon. If the penetration seals are required to accommodate movement, ad hoc tests and / or technical evaluations should be carried out in accordance with ASFP Advisory Note 17 <sup>2</sup> and the PFPF technical assessment guide <sup>3</sup>

### 3.1.21 WHAT INSULATION TYPES ARE INSTALLED AROUND THE SERVICES?

Services are provided with insulation for one of two reasons:

- The insulation may be part of the service design. In this case, it is likely to be continued – ie along the entire length of the pipe. However, this insulation may not be part of the penetration seal
- The insulation may solely be part of the penetration seal, provided to prevent heat transfer and meet the insulation requirement (I) (see Section 3.1.3) for metal pipes and cables passing through the compartment wall. In this case it may be local – ie stopping a short distance either side of the penetration seal (see figure 23).

In cases where the insulation is continued through the penetration seal (sustained in figure 23), then it should be considered as part of the seal. Testing and certification should be carried out with the insulation in place.

The reaction to fire classification must be known for the insulation of the services (pipes) passing through the compartment walls, floors or ceilings.

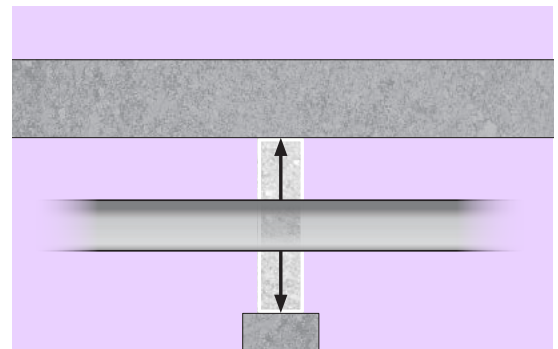
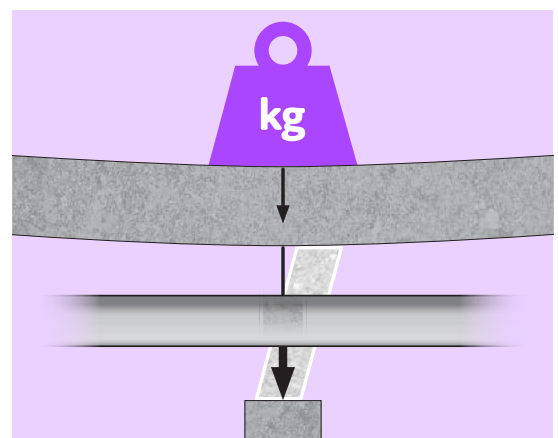

Figure 22 Example of downward deflection of the floor slab



	Sustained	Interrupted
Continued	<p>Case CS</p>	<p>Case CI</p>
Local	<p>Case LS</p>	<p>Case LI</p>

NOTE The insulation may act as penetration seal / may be part of the penetration seal or may be part of the service(s). For further explanation see Annex H.4.1.8.

**Key**

- Building element
- Pipe
- Insulation

Figure 23 Definition of pipe insulation used in BS EN 1366-3

### 3.1.22 HAS THE PIPE PENETRATION BEEN TESTED UNDER THE RELEVANT END CONDITIONS?

Fire tests on pipe penetrations are carried out using a furnace, with one end of the pipe inside and the other outside. Tests are carried out with pipe ends under a variety of conditions – capped or uncapped.

The pressure conditions and flow of hot gases will be different in a pipe that is ventilated to the atmosphere compared with a pipe that is connected to a closed system.

The intended use of pipes in practice can lead to the need for different requirements for pipe end conditions within a test. It is important to ensure the proposed penetration seals have been tested with appropriate pipe end conditions in accordance with the project specification. The required field of application should be checked with the project fire engineer and the building control body.

Table 1 outlines some examples of intended uses in practice where the pipe end conditions can be defined. Not all applications are defined and consideration of whether a system is pressurised, ventilated or unventilated is the basis for deciding pipe-end condition.

### 3.1.23 WILL PENETRATION SEALS BE ACCESSIBLE FROM ONE SIDE OR BOTH DURING INSTALLATION?

Where access is only available from one side of the penetration seal, the designer should ensure that the products selected have test evidence to show their performance when installed with access from one side only.

If the seal is asymmetric, it needs to be tested from both sides or assessed in accordance with the PFPF technical assessment guide [3](#)

Note: to compensate for access only being available from one side of the penetration seal, some manufacturers require a double layer of ablative batt (where only one is required for the fire performance).

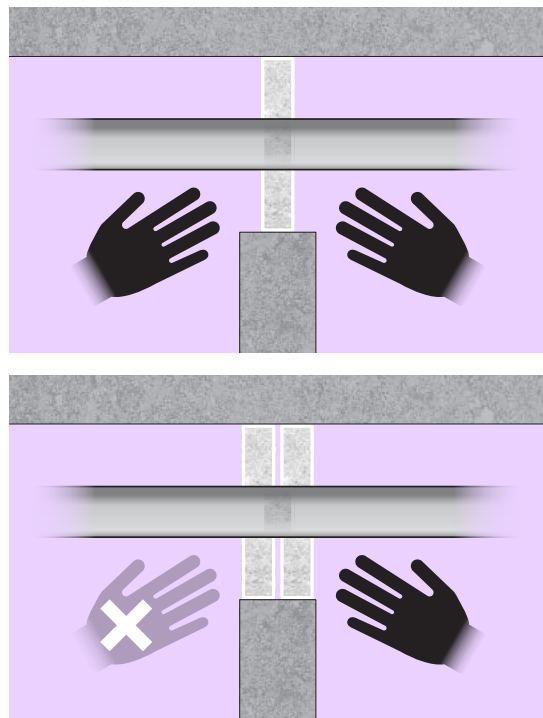

**Figure 24** Access on the left-hand side double-sided access illustrated and on the right-hand side the impact where there is single-sided access only

### 3.1.24 WHAT ARE THE PIPE DIAMETERS?

Approved Document B [6](#) [7](#) states that openings for pipes should meet the following requirements:

*Pipes passing through a fire-separating element, unless in a protected shaft, should comply with one of the alternatives A, B or C below.*

**Alternative A:** *Proprietary seals (any pipe diameter) Provide a proprietary, tested sealing system that will maintain the fire resistance of the wall, floor or cavity barrier.*

### Table 1 Non-combustible pipes

Material of class A1 or A2 in accordance with BS EN 13501-1 **13**  
(steel, copper, stainless steel, cast iron)

INTENDED PIPE USE	SERVICE TYPE	TESTED PIPE END CONDITION	
		Inside furnace	Outside furnace
Systems under pressure and closed systems	Sprinklers; domestic hot and cold water; heating; gas	Capped	Uncapped
Ventilated and closed systems	Rainwater; sewage	Uncapped	Capped
Closed systems	Limited applications	Capped	Capped
All intended uses	All applications	Uncapped	Uncapped

### Combustible pipes

Material of class B to F in accordance with BS EN 13501-1  
(plastic, MCL, composite, multilayer)

Pressurised systems	Sprinklers; domestic hot and cold water; heating; gas	Capped	Uncapped
Closed systems	Heating; sewage	Uncapped	Capped
Ventilated systems	Rainwater; sewage	Capped	Uncapped
Closed systems	Very limited applications	Capped	Capped
All intended uses	All applications	Uncapped	Uncapped

Note: where a pipe joint or fitting is designed to be installed close to a penetration seal the designers should ensure that appropriate test evidence is available to support the design.

**Alternative B:** Pipes with restricted diameter  
Where a proprietary sealing system is not used, firestop around the pipe, keeping the opening for the pipe as small as possible.

**Alternative C:** Sleeving  
A pipe with a maximum nominal internal diameter of 160mm may be used with a sleeve made from a high melting point metal

Note: although Approved Document B provides guidance and alternatives; Alternative B is confusing because it doesn't state the number and positions of the pipes, and is not recommended.

Where Alternative C is being used, it should be supported with relevant test evidence.

This guide provides further guidance on Alternative A only.

### 3.1.25 HAVE THE TYPES OF PLASTIC PIPES BEEN CONSIDERED?

Note: plastic pipes for above-ground soil and waste are not just made of PVC-U.

Designers should consider the various pipe material types when specifying the penetration seal. These are described using the following standards.

- PVC-U: BS EN 1329-1 [21](#)
- Polypropylene BS EN 1451-1 [22](#)
- ABS BS EN 1455-1 [23](#)
- PE BS EN 1519-1 [24](#)
- CPVC BS EN 1566-1 [25](#)
- BS 4514 PVC-U soil and ventilating pipes (82.4mm minimum mean outside diameter).

Additional design considerations:

- Proprietary seals should be used on any pipework passing through a compartment wall or floor
- Where there are plastic pipes and ducts passing through a compartment wall / floor, these should be fitted with a closing device capable of satisfying the criterion; Integrity (E) and Insulation (I) for the required duration, regardless of the size
- Unlagged metal services such as steel pipes may only meet the criterion for Integrity (E)
- The requirement to provide penetration seals for sprinkler pipes should be reviewed.

Penetration seals should meet the criteria for both integrity and insulation. However, where this it is not possible, it should be checked with the BCB and assessed on a project-by-project basis.

### 3.1.26 ARE THERE PARTIAL PENETRATIONS?

A partial penetration is one where the fire-separating element is penetrated on one side only – for example, light switches and sockets.

To maintain the fire performance of the compartment, evidence should be sought from the suppliers of any solutions.

There is currently no specific fire test standard for partial penetrations under the EN 1366 series of tests.

Further information on partial penetrations is provided in ASFP Advisory Note 13 [28](#)

### 3.1.27 DO ANY OPENINGS CARRY MORE THAN ONE TYPE OF SERVICE?

There is currently no specific fire test standard for the installation of fire dampers and ductwork with other service types within the same opening.

Fire dampers and ductwork should not be mixed with other services types in the same opening. However, it may be acceptable to mix other types of services such as pipes and conduits in the same opening where appropriate test evidence exists.

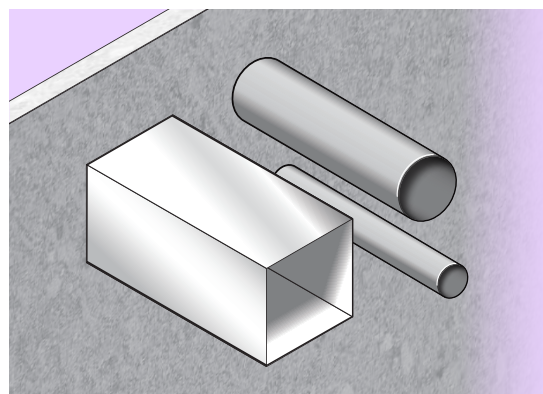

Figure 25 Fire damper

Site-specific testing in a laboratory may be the only option to provide evidence to satisfy the BCB and insurance company.

The design team should satisfy themselves that independent advice has been sought from a competent person in accordance with the PFPF technical assessment guide [3](#) and recorded in the project file.

### **3.1.28 CAN STANDARD SOLUTIONS BE DESIGNED?**

Standardising the size and type of services within an opening will allow for standard solutions and opening sizes to be adopted throughout a project, potentially reducing the risk of error.

On large projects, standardising the letter box openings with associated services and penetration seals allows for uniformity across the scheme.

The service penetration openings should be formed in accordance with substrate manufacturers' recommendations.

Designers should consult with the drylining manufacturers to establish a compliant design – ie lined and unlined if a warranty is required.

A typical example of pre-formed and board-lined service penetration openings is illustrated in figure 10.

### **3.1.29 WHAT IS THE DESIGN LIFE?**

Some manufacturers of penetration seals provide projected life expectancy of products in use. However, there is not a standard to measure these claims against.

Designers should satisfy themselves that the methods used to provide this evidence will satisfy the BCB.

### **3.1.30 IS ACCESS PROVIDED FOR INSPECTION AND MAINTENANCE OF PENETRATION SEALS?**

The designer should provide access to allow the penetration seals to be regularly inspected, as required by the Regulatory Reform Order, and repaired if necessary.

### **3.1.31 WHAT ARE THE LIMITATIONS OF THE SELECTED SERVICE PENETRATION SEAL?**

Some products have limitations on size, depth and application. The designers should consult with the penetration seal manufacturer to ensure the correct product is specified for the application.

For example, the ASFP has guidance on the use of polyurethane foams in the form of an advisory notice [29](#)

Polyurethane foams used for penetration seals must have their performance determined by testing to the appropriate national standards, BS 476-20 [16](#) and BS 476-22 [17](#), or European standard BS EN 1366-3 [12](#)

The ASFP has consistently warned end-users of the risks associated with non-compliant installation with the use of foam for penetration seals applications such as cable trays, pipe services, and general fire sealing of cavities, where typically no test evidence is available.

For further information on the use of foams see the ASFP video titled The correct specification and installation of firestopping [youtu.be/j7wrloB\\_wo8](https://youtu.be/j7wrloB_wo8)

There are specialist foams that are designed and tested to be built up in services penetrations. The designer should check with the manufacturer for compliance and compatibility.

### **3.1.32 ARE CPVC SERVICES USED?**

It is possible that when two products come into contact, they can have an antagonistic effect on one another. This can happen with many interactions between building system components. One area where this can occur involves chemical migration from a sealant into the plastic pipe.

Certain plasticisers common in sealants can migrate into plastic pipes causing the pipe to weaken and eventually fracture under pressure, leading to an escape of water and resulting flood damage. This phenomenon can be particularly critical where CPVC services are used in contact with sealants either providing a firestop, thermal insulation or acoustic insulation. However, it can occur when any material containing plasticisers is in contact with CPVC services. This could include adhesives or materials within collar / sleeve devices that are placed around CPVC services.

CPVC pipes and conduits are sometimes used in buildings – in particular, residential projects tend to use CPVC pipes for sprinkler systems.

Designers should ensure that they are following the CPVC service manufacturer's guidance to ensure compatibility between the penetration seal and the CPVC service.

Where two or more systems come into direct contact, the system owners / manufacturers must be informed and written evidence must be supplied confirming their compatibility and long-term suitability. The manufacturer of the CPVC should provide compatibility statements.

For further guidance, see BAFSA BIF No 8D [26](#) and the FIS technical note on compatibility between pipes and fire and acoustic seals [27](#)

### **3.1.33 ARE THERE ANY SHORT METAL PIPES (SPOOLS) TO BE CONNECTED LATER IN THE PROGRAMME?**

A situation can arise when installing short metal pipes through penetration sealing systems such as collars, wraps and mastics (penetration seals).

Connecting the short pipes using soldering techniques runs the risk of activating the services penetration seals.

Some intumescent materials become active at temperatures as low as 150°C.

Premature activation of the penetration seals can render them ineffective in the event of a subsequent fire. This will result in penetration seals having to be replaced, with subsequent cost and programme implications.

Where spools are utilised, they should extend a sufficient distance either side of the penetration seal to ensure any hot works carried out during installation do not inadvertently activate intumescent materials.

### **3.1.34 ARE THERE ANY BUSBARS?**

Where busbars pass through compartment walls and floors, it is necessary to firestop around it. There may be limited third-party certification for penetration seals around busbars and this should be checked with the penetration seals system owner.



# 4 TECHNICAL DESIGN

## 4 Technical Design

### GOLDEN RULE 5

Only select firestopping products which are third party certified by a UKAS accredited organisation. Firestopping products should be certified or CE marked and tested using the relevant standards.

### GOLDEN RULE 6

Ideally select one firestopping manufacturer throughout the project. Products from different manufacturers should not be mixed in the same opening unless there is clear test evidence to substantiate their use.

### GOLDEN RULE 7

Request copies of the third party certification from the manufacturers. These should be reviewed by a suitably qualified person to ensure the certification and field of application is relevant for the situation.

#### WHO DOES THIS APPLY TO?

- Designers
- Installers
- Inspectors
- Owner / occupiers

## 4.1 SPECIFICATION

The most common methods used by designers for the selection and specification of building services and penetration seals systems are noted below.

Collaboration and communication are key to a compliant specification and it should be noted that any changes made to the specification at any stage will turn whoever makes those changes into the designer.

Key points to be considered when writing a specification:

- Talk to the manufacturer
- Performance is king (fire, acoustics etc)
- Consider the interface with other elements
- Understand the use, now and in the future
- Understand the budget
- Understand the programme and site conditions
- Understand the vision and client aspiration
- Ensure the performance and workmanship requirements and standards are clearly included
- Understand the implications of maintenance
- Understand the environmental implications and what will happen at end of life
- Do not be scared of specifying new products.

The National Building Specification (NBS) building clause includes:

- B05 Whole building fire safety
- P12 Fire stopping systems
- P31 Holes, chases, covers and supports for services.

A good specification should be developed with competent people from:

- Manufacturers / suppliers
- Architect or designer
- Specialist installer
- Fire engineer
- M&E consultants.

The specification should include (the following list is not exhaustive):

- Product name and reference
- Detail references
- Performance requirements and supporting evidence
- Field of application
- Structural performance
- Environmental conditions
- Movement accommodation
- Substrate specification
- Sample mock-ups and quality benchmarks
- Tolerances
- Thermal performance
- Humidity

- Air permeability
- Acoustic performance
- Life expectancy and durability
- Third-party certification
- Colour
- Manufacturers' details
- Special instructions
- Protection from damage during construction phase
- Installation (third-party certified installers)
- Inspection and preparation.

## 4.2 SPECIFICATION AND TESTING OF PENETRATION SEAL PRODUCTS / ARRANGEMENTS

Approved Document B **6 7** states the following with regard to the protection of openings and penetration seals:

*The performance of a fire-separation element should not be impaired. Every joint, imperfect fit and opening for services should be sealed. Firestopping delays the spread of fire and, generally, the spread of smoke as well.*

### 4.2.1 BS EN 1366 FIRE RESISTANCE TESTS FOR SERVICE INSTALLATIONS

BS EN 1366 is a series of 13 test standards. The standards in bold are relevant to this guide:

#### **Part 1: Ducts**

#### **Part 2: Fire dampers**

#### **Part 3: Penetration seals**

Part 4: Linear joint seals

#### **Part 5: Service ducts and shafts**

Part 6: Raised access and hollow core floors

Part 7: Conveyor systems and their closures

#### **Part 8: Smoke extraction ducts**

#### **Part 9: Single compartment smoke extraction ducts**

#### **Part 10: Smoke control dampers**

Part 11: Fire protective systems for cable systems and associated components

Part 12: Non-mechanical fire barrier for ventilation ductwork

Part 13: Chimneys

**Figure 26** Guidance on product selection

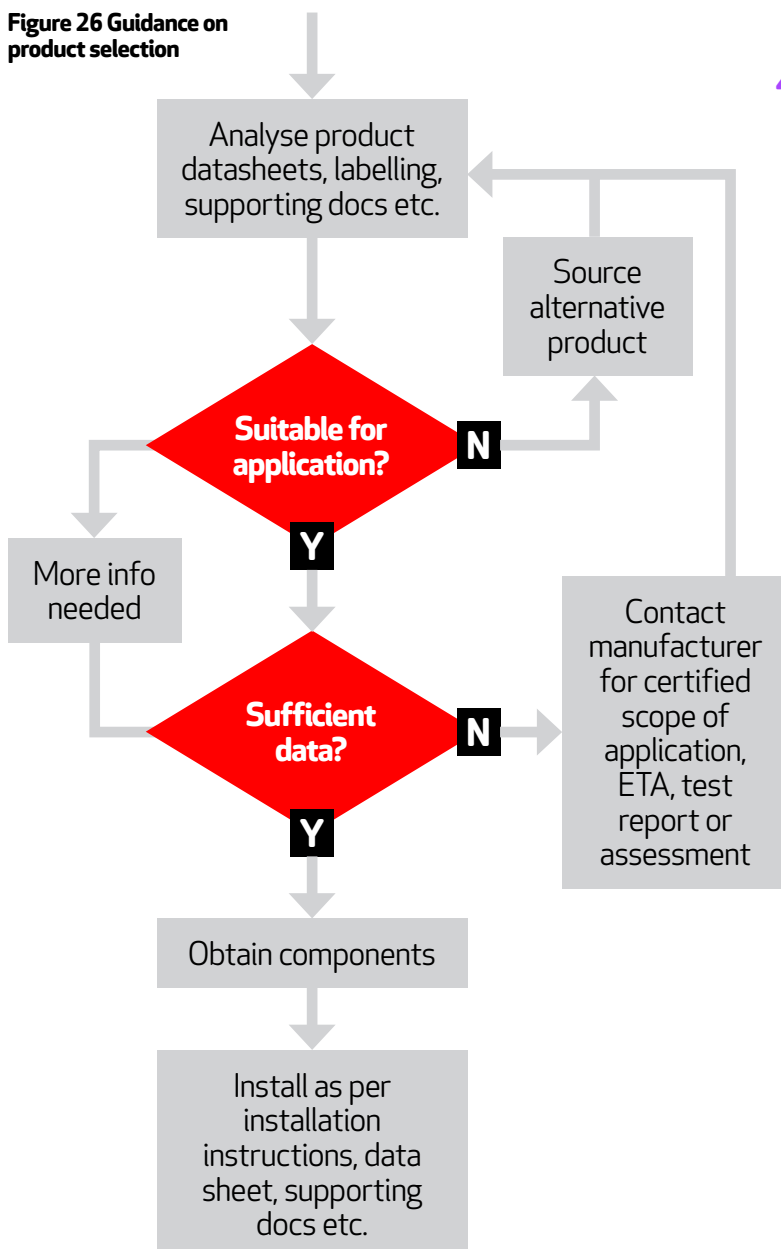

BS EN 1366-3 [12](#) specifies a method of test and criteria for the evaluation (including field of application rules) of the ability of a penetration seal to maintain the fire resistance of a fire-separating element at the position at which it has been penetrated by a service.

BS EN 1366-3 assesses:

- The effect of service penetrations on the integrity and insulation performance of the fire-separating element concerned.
- The integrity and insulation performance of the penetration seal.
- The insulation performance of the penetrating service or services and, where necessary, the integrity failure of a service.

In addition to the BS EN 1366 series of standards, there are also numerous historic (and some current) BS 476 standards.

Some penetration seal products may have test evidence created by ad hoc testing to BS 476: 20. The testing is deemed ad hoc because there is no British Standard specifically dealing with penetration seals.

No information can be implied by the test concerning the influence of the inclusion of penetrations and sealing systems on the loadbearing capacity of the fire-separating element.

### 4.3 CE MARKING AND CERTIFICATION

Under the Construction Products Regulation (CPR), CE marking of construction products becomes mandatory once a harmonised product standard (hEN) has been published. At the current time, there is no hEN for passive fire protection products tested to BS EN

1366 [10](#). Therefore, it is not mandatory for passive fire protection systems to be CE marked in accordance with the CPR.

Currently any CE marking is done voluntarily in accordance with rules laid down by the European Organisation for Technical Assessment (EOTA). EOTA has published a set of rules against which products are assessed for their performance. These rules are contained within European Assessment Documents (EADs). The EAD for passive fire protection tested to BS EN 1366-3 [12](#) is EAD 350454-00-1104 [30](#)

If a manufacturer elects to use CE marking as their route to demonstrate constancy of performance, then they are required by the CPR to provide a Declaration of Performance (DoP) for their product. This document provides key information on the performance of a product.

CE marking indicates that a construction product conforms with its declared performance and that it has been assessed according to a harmonised European Standard or a European Technical Assessment has been issued for it.

It should be stressed that a CE marking by either of these routes is based upon an assessment of performance. It is up to members of a project team to verify that the assessed performance of a product meets their needs. A European Technical Assessment is not a de facto approval.

CE marking is not the only way in which a product can demonstrate constancy of performance. It is also possible for data from BS EN 1366-3 tests to be third-party certified against other requirements. There are a number of UKAS-accredited third-party certification schemes operating in the UK, which also provide additional confidence in the ongoing product performance.

COMPANY NAME

According to Annex III of the Regulation (EU) Nr.305/2011 (Construction Products Regulation)

XXXX-CPR-XXXXXX

PRODUCT  
FIRE BATT**1. Unique identification code of product-type:**

XXXXXX

EN

**2.Type, Batch or serial number as required pursuant to Article 11(4):**

See ETA XX/XX : See batch number displayed in product

**3. Intended use or uses of construction product, in accordance with the applicable harmonized technical specification:**

Fire Stopping and Sealing Products for Penetration Seal, See ETA XX/XXX

Cable Penetrations	Insulated & non insulated, cables, cables trays & cable ladders	The field of application has to comply with the content of ETA XX/XXXX
Pipe Penetrations	Insulated & non insulated metal pipes	The field of application has to comply with the content of ETA XX/XXXX

**4. Name, registered trade name or registered trade mark and contact address as required pursuant to article 11(5):**

COMPANY ADDRESS

**5. Authorized representative: N/A****6. System or systems of assessment and verification of performance of the construction product as set out in Annex V: AVCP - System 1****7. Harmonized standard: N/A****8. In case of the declaration of performance concerning a construction product for which a European Technical Assessment has been issued:**

Element issued European technical approval - ETA XX/XXXX on the basis of EAD 350454-00-1104 Fire Stopping and Fire Sealing Products &amp; issued certificate of conformity XXXX-CPR-XXXXXX

**9. Declared performance:**

Essential Characteristics	Performance/Harmonised technical specification
Reaction to Fire	Class A-F according to EN13051-1
Fire Resistance	Resistance to fire performance & field of application in accordance with EN13501-2 See ETA XX/XXXX clause 3.2 - Annex C
Air Permeability	Tested in accordance with EN 1026, See ETA XX/XXXX Clause XYZ
Dangerous Substances	See ETA XX/XXXX Clause XYZ
Protection Against Noise	See PRODUCT - Rw (C;Ctr) - 32dB & 21dB
Service & Durability	Z <sub>1</sub> (0/+40oc) intended for use at internal conditions with high humidity (85%) in accordance with EOTA technical documents TR024
Other	Not applicable/No performance determined

10. The performance of the product identified in points 1 and 2 is in conformity with the declared performance in point 6. This declaration of performance is issued under the sole responsibility of the manufacturer identified in point 4.

Signed for and on behalf of the manufacturer by:

SIGNATURE

DATE

SIGNATURE

DATE

COMPANY REPRESENTATIVE

COMPANY REPRESENTATIVE

COMPANY ADDRESS

Tel: +44 (0) 1234 56789  
 Fax: +44 (0) 1234 56789  
 Email: sales@ACME.com  
 Website: www.ACME.com

Figure 27 Parameters required in a DoP

## 4.4 PRODUCT CERTIFICATION SCHEMES

There are a number of industry-recognised third-party certification schemes available, covering a wide range of penetration seals and fire sealing products.

Independent third-party certification schemes formally assure performance, quality, reliability and traceability of fire protection products.

Recognised by many regulatory authorities, these schemes are a respected mark of fire safety.

The fundamental benefit to any third-party scheme is focused around giving the regulator, specifier, customer and end-user confidence regarding the stated performance of the product and provides an informed choice when purchasing or selecting such components in the first place.

Choosing a product that carries the mark of a reputable third-party certification body gives assurances as to the overall performance and effectiveness of that product.

Using correctly installed certificated products provides a powerful demonstration that due diligences have been served.

## 4.5 TECHNICAL EVALUATIONS

In her report 'Building a Safer Future' <sup>31</sup> Dame Judith Hackitt recommended that the government restrict the use of Assessments in Lieu of Tests (AIIOTs) and require that all AIIOTs be used appropriately and carried out by competent individuals.



**Figure 28** Examples of third-party UKAS-accredited certification schemes for passive fire protection products

The current situation is that assessments and technical evaluations (sometimes referred to as engineering judgements) are still widely carried out and there are a number of areas where they remain an important part of the construction process.

There are two key types of assessment that need to be considered. First, there are assessments written around rules contained within published test standards such as BS EN 1366-3 <sup>12</sup> or Extended Application standards (EXAPs). These rules give some very clear interpretation over which scenarios can be claimed using testing as a basis for justification. The rules are published within the test or EXAP standard. These standards and the rules within are reviewed and updated through well documented BSI / CEN committees.

The second route is a less formal technical evaluation. These technical evaluations are needed in several scenarios. There may be no appropriate standard test method (such as looking at the interaction between a structural frame and a compartmentation system). It may also be that a full-scale test is impossible due to furnace size limits or it is impractical to test every variation of a particular theme such as firestopping penetrations. Test evidence must still, however, be used and referenced as the foundation for any assessment.

ASFP Advisory Note 17 **2** gives more detail of situations where assessments and technical evaluations can be used, and where an evaluation would be inappropriate.

Guidance on how assessments and technical evaluations should be carried out is given in the PFPF technical assessment guide **3**. An assessment produced in line with the PFPF technical assessment guide should be written such that any other party could review the underpinning results, the logic behind any conclusion and details of the competence of the assessors involved.

Assessments and technical evaluations should be based on suitable test evidence for the specific performance characteristic under review. Where an expansion of the scope of application is sought – ie reaction to fire, fire resistance or smoke control test – evidence on the same or similar product performance tested to the relevant performance characteristic should be supplied. For example, a comparison of reaction to fire evidence should not be used to justify a fire resistance evaluation.

Therefore, by the same token, assessments and technical evaluations should not be written without suitable test evidence, which can be referenced as the foundation for any expansion of scope. For example, equivalent reaction to fire performance cannot be used to justify a product switch in a fire resistance application.

Technical evaluations can be undertaken by test laboratories, certification bodies, other fire consultants and / or manufacturers (on their own products). In fact, technical evaluations are a form of assessment and the conflict of interest in such an assessment undertaken by the manufacturer concerned is usually very apparent.

The PFPF technical assessment guide allows engineering judgements provided that any conflict of interest is managed and apparent. Any technical evaluation produced for a scenario encountered on a construction site should be limited to use on a single named project.

## **4.6 ADEQUATE SUPPORT OF SERVICES**

The fire performance of the completed installation can only be warranted if the distances to the centres of the supports for the services on either side of the penetration seals are the same as or less than those covered by the fire test, technical evaluation (assessment) or certification evidence provided by the manufacturer.



**Figure 29 Support of services on either side of the compartment**

The supports required for maintaining the fire performance of penetration seals are in addition to the supports required to support the services.

Further information about support of services can be found in section 3.18 of the ASFP Red Book [32](#) and ASFP Advisory Note 8 [33](#)

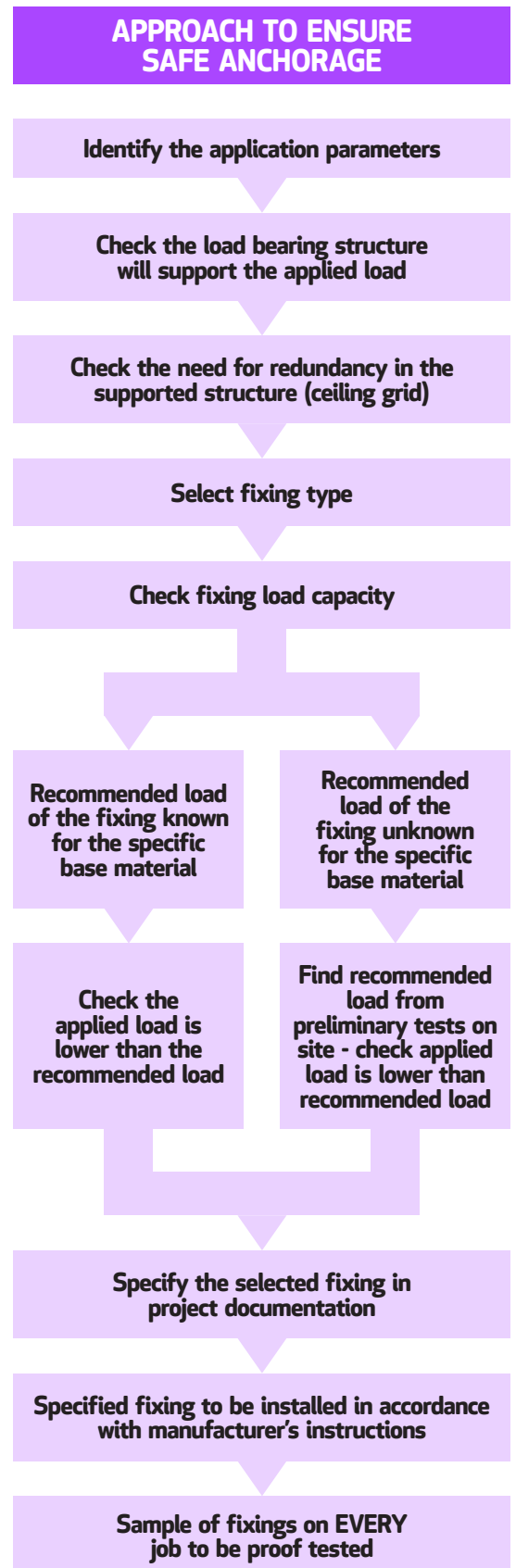

**Figure 30 Approach to ensure safe anchorage (from the FIS and CFA Best Practice Guide 'Selection and installation of top fixings for suspended ceilings'.**

# 5 MANUFACTURING AND CONSTRUCTION



Manufacturing and Construction

## GOLDEN RULE 8

Ensure the installers of ALL service penetration seals are third party certified by an organisation such as FIRAS, LPCB, IFC, BM TRADA etc.

## GOLDEN RULE 9

Implement a structured inspection plan to include photographic evidence as the work proceeds.

### WHO DOES THIS APPLY TO?

- Designers
- Installers
- Fire and rescue authorities
- Manufacturers
- Inspectors
- Owner / occupiers

## 5.1 QUALITY

The following 'PPP' process should be used to provide a record of what has been installed:

**Product** Keep records of the specification, test evidence, purchase orders and delivery notes.

**Process** Keep dated site images of the installation, especially elements that will be covered up in the final build.

**People** Keep records of the skill, attitude, knowledge and experience of any person who installed the system.

Information on the FIS Product Process People quality framework can be found at [thefis.org/knowledge-hub/product-process-people](http://thefis.org/knowledge-hub/product-process-people)

## 5.2 BENCHMARKING AND SAMPLES

Once the type of service penetrations is established, the design layout determined, the penetration seals and fixings specified and a penetration manufacturer selected, a sample wall and floor should be constructed for the project. This will allow each type of firestop to be replicated (where practicable to do so) and this can be used as a control sample for all to see and understand.

Making these sample boards mobile ensures that they can be used as a quality control benchmark across the build.

These samples and benchmarks will assist in the inspection of the penetration seals on site and can be used for toolbox talks with the operatives.

It is also imperative that benchmarks of each penetration seal type is constructed on site and signed off by all the relevant people. This could include the architect, specialist consultants, the main contractor and clerk of works.

When checking the benchmarks, reference should be made to the samples plus the specification, project details and agreements between parties.

Benchmarking is good practice for projects of all sizes. However, the use of samples may be appropriate for larger projects only and could be disproportionately time-consuming and expensive for smaller projects.

## 5.3 INSTALLATION

Everybody involved with the design and installation of penetration seals shares the responsibility for their performance in the case of a fire.





**Figure 31** A sample of a penetration seal system

This would include:

- The client
- The principal designer
- The principal contractor
- Designers
- Contractors.

It is essential that when a penetration seals specialist is appointed, that their competence can be proved. One way to demonstrate this is to appoint a third-party certified specialist installer that only uses third-party certified penetration seal products.

Each service penetration should be given a unique reference number, and these should be logged with details of the penetration seal, the size of the opening and construction details.

The service penetration should be inspected by the duty holder for compliance with the design before the services are installed.

After the services are installed within the service penetration, they should be handed over to the third-party certified specialist penetration seal installer for inspection before the penetration seals are installed.

The third-party certified specialist penetration seal installer should then hand back the completed installation for inspection by the duty holder and agree that the work has been completed satisfactory.

It is recommended that photographic evidence, referenced against each unique number, is held on file to become part of the handover information (see section 6 on Regulation 38).

## 5.4 THIRD-PARTY INSTALLATION CERTIFICATION SCHEMES

Third-party certification from independent UKAS-accredited bodies for installers is a process whereby the contracting company is seen to employ appropriately trained and competent staff to install the required passive fire protection system.

Their work is independently audited by site inspections from the independent third-party organisation and a full record system is required as part of the scheme. A record of installation is issued on completion to the main contractor for each contract.

The use of independent third party certification and accreditation is recognised in Approved Document B **6 7**

The use of certified installers will reduce the incidence of firestopping materials being installed by unskilled contractors and the use of unsuitable materials and reduce essential work and rework considerably. These autonomous schemes raise the profile of the supply and installation chain and provide the client with evidence of compliance. Various independent third-party certification schemes are available, and the main contractor should select an appropriate scheme if the client has not already specified one.

The scheme should include:

- Verification of the skills and training of management, designers and estimators
- Use of suitable materials in accordance with approved details
- Training of operatives and supervisors in the product they are installing

**Figure 33 Electronic recording of a penetration seal installation**

- Random inspection of sites to monitor the quality of work
- Provision of a Record of Installation for completed work
- An audit trail
- UKAS accreditation.

Examples of installer certification schemes:

Warringtonfire

[warringtonfire.com/certification-services/fire-certification/firas](http://warringtonfire.com/certification-services/fire-certification/firas)

IFC

[ifccertification.com/certification/installer-certification.html](http://ifccertification.com/certification/installer-certification.html)

BRE

[bregroup.com/services/certification-and-listings/](http://bregroup.com/services/certification-and-listings/)

BM TRADA

[bmtrada.com/certification-services/third-party-certification-fire/q-mark-firestopping-installation-scheme](http://bmtrada.com/certification-services/third-party-certification-fire/q-mark-firestopping-installation-scheme)

## 5.5 SEQUENCING OF THE INSPECTION WORK

Inspection of the works should be sequenced and planned to ensure that they are installed compliantly.

Guidance on the installation and inspection of penetration seals is given in ASFP Technical Guidance Note 17 <sup>34</sup>. This provides a matrix of the inspection regime suggesting the proportion of the works to be inspected.

The following checks should be carried out as a minimum prior to any installation of a penetration seal:

- Everyone has signed off what is to be installed
- The installers are competent and understand what is to be installed
- The design of the penetration seal is understood, and the manufacturer's instructions are available

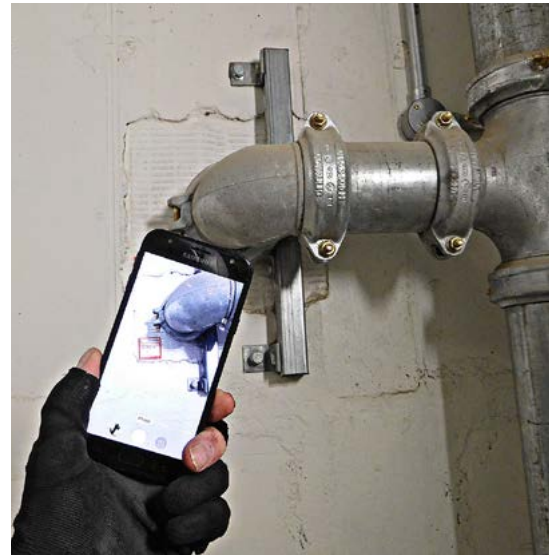

- The penetration seal system selected is suitable for the substrate in which it is to be installed
- The opening is formed compliantly
- Penetrating services are compliantly supported at the spacings described in the third-party certification
- Penetrating services are installed to ensure compliant edge distances and spacings
- The correct services are contained within the penetration seal and not mixed outside the scope of the third-party certification
- There is adequate and safe access to install compliant penetration seals.

Once pre-installation checks have been carried out, an inspection regime should be undertaken and detailed in a record of installation.

The penetration seal works must be inspected by someone within the same company, other than the installing operative, who has responsibility for checking and signing off the work, including the placing of the label demonstrating this. Photographs should be taken before, during and after installation. There are several electronic systems designed for monitoring the installation of penetration seals and these should be encouraged as they provide systems to accurately log the penetration seals and should form part of the Regulation 38 information.

Anyone who carries out the inspection of penetration seals onsite should be competent to do so.

## 5.6 COMPETENCY SCHEME

The ASFP foundation course in passive fire protection provides essential knowledge as part of demonstrating competency and understanding in this key fire protection specialism.

The content of the training embeds current best practice and draws on the technical expertise provided by the ASFP. The foundation courses have been developed in partnership by ASFP and the Institution of Fire Engineers (IFE), a nationally and internationally established awarding organisation, recognised by the qualification regulator Ofqual.

The foundation courses aim to equip candidates with the knowledge required to demonstrate competency, while also offering a route for progression and academic recognition in this key fire protection specialism.

The level 2 course is designed for installation team leaders and senior installers, whilst the level 3 course is suggested for anyone who works in the design or inspection / assessment of passive fire protection.



## 5.7 FIRE PREVENTION ON CONSTRUCTION SITES AND BUILDINGS UNDERGOING RENOVATION

The Joint Code of Practice Fire Prevention on Construction Sites and Checklist **43**, published by the Fire Protection Association, applies to activities carried out prior to and during the procurement, construction and design process.

It is commonly referred to in insurance contracts and is recognised as best practice.

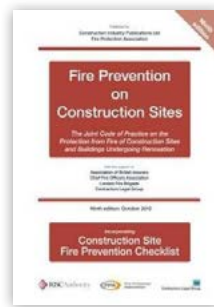

It also includes a checklist, which converts the Joint Code into a series of questions that should be asked to establish whether fire precautions on a site are comprehensive and adequate.

The checklist uses a tick-box principle and contains space for notes and comments.

This publication is suitable for all parties responsible for fire safety prior to and during the procurement, construction and design process.

Appendix A contains a list of further industry guidance.

## 5.8 LABELLING OF FIRE SEPARATING ELEMENTS

Service penetration seals should be clearly labelled by the specialist contractor on completion with the following information:

- Unique reference number of the penetration and the seal
- Installation date
- Name of the operative who installed the seal
- Name of the supervisor who inspected the seal
- Name and contact details of the manufacturer
- Name and contact details of the specialist contractor
- Date of next inspection.

ASFP and FIS have a Fire Performance Partition Labelling Scheme as part of a commitment to improve safety. This aims to identify fire-separating elements to installers, M&E contractors, building owners and facilities managers and to highlight the risks of cutting holes in them for services.

More information is available at [asfp.org.uk/fire-performance-labelling-scheme/](http://asfp.org.uk/fire-performance-labelling-scheme/)



# 6 HANDOVER

6



## Handover

### WHO DOES THIS APPLY TO?

- Designers
- Installers
- Inspectors
- Owner / occupiers
- Fire and rescue authorities

## 6.1 MANUFACTURERS' INSTRUCTIONS

Penetration seals will need to be maintained in accordance with any manufacturers' recommendations and instructions. Therefore, it is vital that these are provided at handover.

Manufacturers' technical departments should be consulted at the earliest opportunity to obtain copies of all evidence required to be handed to the building owners as part of the Regulatory Reform (Fire Safety) Order (RRFSO) and Regulation 38.

## 6.2 BUILDING REGULATIONS COMPLETION CERTIFICATE

When the building control body is satisfied that the works (as far as they can ascertain) demonstrate compliance with the regulations, a completion or final certificate will be issued.

The BCB will therefore need to be satisfied that any penetration seals have been installed correctly. Therefore, liaising with the BCB will be necessary during the project.

## 6.3 O&M INFORMATION

The operation and maintenance (O&M) manual contains the information required for the operation, maintenance, decommissioning and demolition of a building.

The information required by Regulation 38 is separate from the O&M manual and should be provided separately to the building owner (see Appendix A).

The following information should be provided as a minimum in relation to the penetration seals:

- Details of penetration seals installed on the project, including project-specific penetration seal details
- Photographs
- Quality check records
- Plans showing where the firestopping is installed
- Full performance requirements of the penetration seals eg E / I or E
- Future inspection requirements.

# 7 USE



## WHO DOES THIS APPLY TO?

- Inspectors
- Fire and rescue authorities
- Owner / occupiers

## 7.1 INSPECTION / MAINTENANCE

Reference should be made to ASFP TGD 17 [34](#) and the BESA online service SFG20 [44](#)

### TGD 17

This is a code of practice produced by the ASFP for the installation and inspection of penetration seals systems in buildings for linear joint seals, penetration seals and small cavity barriers. It is recommended that this guidance is used when inspecting penetration seals.

### SFG20

This is the standard, produced by BESA, for planned maintenance and is the tool for facilities managers, building owners, contractors and consultants to stay compliant and save time, energy and money.

## 7.2 POST-COMPLETION ADDITIONAL PENETRATIONS

Any new penetration seals installed after completion should comply with this guide.

# APPENDIX A REGULATIONS, STANDARDS AND INDUSTRY GUIDANCE

This guide references regulations currently applicable in England. Where different regulations apply in other constituent countries of the UK, this is noted, but detailed information is not provided on these.

## A.1 BUILDING REGULATIONS

The Building Regulations are a set of legal requirements that apply when building work is carried out. Functional requirements, ie those relating to specific technical areas of building work, are contained in Schedule 1, which is divided into parts A to R.

The definition of building work includes new buildings, extensions and material changes of use, for example converting a house to flats. Importantly in the context of this guide, material alterations to existing buildings are also classified as building work. These include alterations which would result, at any stage of the work, in the building being less compliant with the fire safety requirements of the Building Regulations. For example, making a penetration through a fire-separating element in an existing building would classify as a material alteration, and would therefore require approval of a building control body.

The entire text of the Building Regulations can be found at [legislation.gov.uk/uksi/2010/2214/contents](http://legislation.gov.uk/uksi/2010/2214/contents)

Separate Building Regulations apply in Wales, Scotland and Northern Ireland, however, these contain broadly similar requirements.

### A.1.1 LEGAL REQUIREMENTS

#### Part B

Part B of Schedule 1 of the Building Regulations contains the primary requirements relating to fire safety. Requirement B3 is pertinent to this guide and can be paraphrased as follows:

*Where reasonably necessary to inhibit the spread of fire within the building, measures shall be taken, to an extent appropriate to the size and intended use of the building, comprising...sub-division of the building with fire-resisting construction.*

This sub-division is normally called compartmentation. Firestopping is an essential component of the integrity of compartment walls and floors. Guidance on meeting the Part B requirements, including B3 can be found in Approved Document B **6 7** which is discussed in section A.1.2.

#### Regulation 7

Regulation 7, which applies to all work covered by requirements in Schedule 1, including fire safety requirements, reads as follows:

*Building work shall be carried out –*

- a) with adequate and proper materials which –*
  - i) are appropriate for the circumstances in which they are used,*
  - ii) are adequately mixed or prepared, and*
  - iii) are applied, used or fixed so as adequately to perform the functions for which they are designed; and*
- b) in a workmanlike manner.*

This regulation essentially gives powers to building control bodies to reject work which is not satisfactory. Guidance on Regulation 7 is provided in an Approved Document, which is discussed in section A.1.2.

### **Regulation 38**

Passing on the correct fire safety information to the responsible person (as defined under RRF50 – see section A2) at the completion of a project is a requirement under the Building Regulations, and this is the requirement of Regulation 38F4F0F0F .

This regulation aims to ensure that information critical to the life safety of people in and around the building is communicated to the owner, occupier and / or end user, so that the building can be operated and managed correctly.

It should ensure that the fire safety strategy given to the responsible person is correct and accurately reflects the fire safety precautions in the building.

This enables the responsible person to conduct a suitable and sufficient fire risk assessment for the building. It will accurately record the physical fire safety precautions in place, and so enable risks to the relevant persons in the building to be understood in a way that allows them to be appropriately addressed.

The design team may not fully appreciate or understand the importance of providing the correct 'as built' fire safety information to the responsible person during the design and construction phases of a building. This has to be considered to ensure the correct information is being collated during this process. It is important to note that the design team may be held responsible in the event of a near miss or a fire if this is not done.

The approving authorities could contest the building's fire risk assessment for not being suitable or sufficient to meet the requirements of the Regulatory Reform (Fire Safety) Order 2005 if the information required by Regulation 38F5F1F1F is not provided by the design team. The full text of regulation 38 is:

- 1) *This regulation applies where building work –*
  - a) *consists of or includes the erection or extension of a relevant building; or*
  - b) *is carried out in connection with a relevant change of use of a building, and Part B of Schedule 1 imposes a requirement in relation to the work.*
- 2) *The person carrying out the work shall give fire safety information to the responsible person not later than the date of completion of the work, or the date of occupation of the building or extension, whichever is the earlier.*
- 3) *In this regulation –*
  - a) *“fire safety information” means information relating to the design and construction of the building or extension, and the services, fittings and equipment provided in or in connection with the building or extension which will assist the responsible person to operate and maintain the building or extension with reasonable safety;*
  - b) *a “relevant building” is a building to which the Regulatory Reform (Fire Safety) Order 2005 applies, or will apply after the completion of building work;*
  - c) *a “relevant change of use” is a material change of use where, after the change of use takes place, the Regulatory Reform (Fire Safety) Order 2005 will apply, or continue to apply, to the building; and*
  - d) *“responsible person” has the meaning given by article 3 of the Regulatory Reform (Fire Safety) Order 2005.*

Guidance on Regulation 38 can be found in Approved Document B **6 7** (see section A.1.2).

## A.1.2 APPROVED GUIDANCE

Guidance on ways of meeting the Building Regulations is provided in government-published Approved Documents. These do not provide guidance on every conceivable type of building work but are intended to cover most common types. Also, they are not the only means of showing compliance with Building Regulations – the applicant is entitled to provide alternative evidence in support of their application. However, in these cases, the applicant would normally be expected to show that their proposed solution is at least as effective in meeting the legal requirements as one which meets the guidance in the Approved Documents.

### England Approved Documents

[gov.uk/government/collections/approved-documents](http://gov.uk/government/collections/approved-documents).

### Wales Approved Documents

[gov.wales/building-regulations-approved-documents](http://gov.wales/building-regulations-approved-documents)

### Scotland Building Regulations Technical Handbooks

[gov.scot/policies/building-standards/monitoring-improving-building-regulations/](http://gov.scot/policies/building-standards/monitoring-improving-building-regulations/)

### Northern Ireland Building Regulations Technical Booklets

[finance-ni.gov.uk/articles/building-regulations-technical-booklets](http://finance-ni.gov.uk/articles/building-regulations-technical-booklets)

## A.1.3 APPROVED DOCUMENT B

Approved Document B provides guidance on meeting the functional requirements of Part B of Schedule 1, and also Regulation 38, of the Building Regulations. It is published in two volumes: Approved Document B: Fire Safety – Volume 1: Dwellings **6**; Approved Document B: Fire

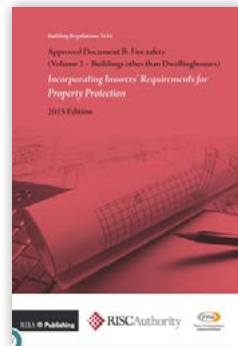

Safety – Volume 2: Buildings other than Dwellings **7**

It should be noted that blocks of flats are covered under Volume 1.

The Risk Insight, Strategy and Control Authority (RISC Authority) and the Fire Protection Association (FPA) publish an annotated version **35** of Approved Document B Volume 2. It provides additional technical guidance about how to protect commercial buildings from fire, beyond meeting the Building Regulations requirements, which are focused strictly on life safety. Although this additional technical guidance is focused on property protection, in many cases, following this guidance will provide higher levels of life safety protection than those afforded by the non-annotated version of Approved Document B Volume 2. It should, however, be noted that this annotated version was last updated in 2015, whereas the non-annotated version has been updated more than once since then.

Guidance on firestopping of service penetrations can be found in section 9 of Volume 1 and section 10 of Volume 2.

Approved Document B refers to additional guidance for schools and healthcare facilities, which are discussed in the sections below.

## A.1.4 BUILDING BULLETIN 100

Building Bulletin 100 **38** (generally abbreviated to BB100) is a design guide that shows clearly how the requirements for life safety, contained in the Building Regulations, can be met in the design of new schools and extensions in England and Wales. It also covers the principles of fire

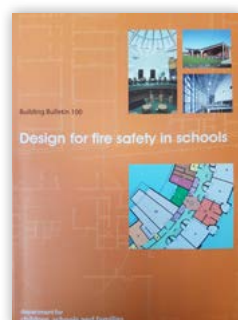



safety management and describes the fire protection measures that the designer should consider. It is largely based on Approved Document B **6** **7** (see section A.1.4), however, its scope is wider.

### A.1.5 HEALTH TECHNICAL MEMORANDUM 05-02

Health Technical Memorandum 05-02 **39** (generally abbreviated to HTM 05-02)



provides information on fire safety in the design of new healthcare buildings and extensions. It provides comprehensive guidance and advice on the design, installation and operation of the specialised building and engineering technology used in the delivery of healthcare.

The guidance is applicable to both new and existing sites and for use during the whole lifecycle of the buildings.

### A.2 REGULATORY REFORM (FIRE SAFETY) ORDER 2005

The Regulatory Reform (Fire Safety) Order 2005 (RRFSO) came into effect on 1 October 2006. Prior to this time there were over 100 separate pieces of fire-related legislation, which were then revoked or amended. The order is designed to provide a minimum fire safety standard for all non-domestic premises, with very few exceptions. It is primary legislation for fire safety in England and Wales. Scotland and Northern Ireland have separate fire safety legislation.

In general terms, the RRFSO reflects the duties and approach contained within the Management of Health and Safety at

Work Regulations 1999 (MHSW) and employees' duties under the Health and Safety at Work Act 1974 (HSWA).

There are significant fire-specific issues that the RRFSO covers in some detail, which include:

- The notion of a responsible person
- The duty for responsible persons to take general fire precautions
- The need to conduct a fire risk assessment
- The control of risks from dangerous substances
- Firefighting and detection
- Emergency routes and exits
- Powers of inspectors and enforcement actions (differing from general health and safety).

#### Responsible person

The RRFSO refers to a responsible person, defined as a specified individual who is responsible for fire safety.

The meaning of the term responsible person is defined by the RRFSO as:

- In relation to a workplace, the employer, if the workplace is to any extent under their control
- In relation to any premises not falling within the above:
  - The person who has control of the premises (as occupier or otherwise) in connection with the carrying on by them of a trade, business or other undertaking (for profit or not)
  - The owner, where the person in control of the premises does not have control in connection with the carrying on by that person of a trade, business or other undertaking.

The responsible person is the main duty holder for fire safety and has, as a result, overall responsibility for:

- Undertaking the fire risk assessment

- Putting precautions in place to safeguard employees and non-employees
- Ensuring that testing and maintenance are carried out for aspects such as: fire detection and alarm systems; firefighting equipment; emergency exit routes and fire exits; fire evacuation drills and assembly points.

The responsible person is responsible for appropriate training, provision of information and a variety of other duties relating to the management of fire safety, such as the protection of young people, managing risks from explosive atmospheres, consulting with employees and other relevant persons.

### **General fire precautions**

The RRFSO identifies a number of general fire precautions that all responsible persons have an absolute duty to provide for all non-domestic premises. These general fire precautions are the measures that are taken:

- To reduce the risk of fire and fire spread
- In relation to the means of escape (MoE) from the premises
- For ensuring that the MoE can be safely and effectively used at all material times
- In relation to fire fighting on the premises
- In relation to detecting and giving warning in case of fire
- In relation to emergency action to be taken in the event of fire, including training and mitigating the effects of fire.

### **The need to conduct a risk assessment**

The responsible person is required to ensure that a fire risk assessment is carried out. It is acceptable for the responsible person to pass this task to

another suitably qualified person, although this does not exonerate their obligations in law. If a qualified fire risk assessor is chosen to carry out the assessment, they should be a member of a certification scheme such as the Warringtonfire Risk Assessors Certification Scheme (FRACS) [warringtonfire.com/certification-services/fire-certification/fracs](http://warringtonfire.com/certification-services/fire-certification/fracs)) or the BAFE Life Safety Fire Risk Assessment scheme [bafe.org.uk/schemes/life-safety-fire-risk-assessment-sp205/](http://bafe.org.uk/schemes/life-safety-fire-risk-assessment-sp205/)

Employers, as responsible persons, have a duty to do all that is reasonably practicable to safeguard 'relevant persons' (who may be employees and people who are not employees) but who may be exposed to risk in the event of fire.

## **A.3 CONSTRUCTION (DESIGN AND MANAGEMENT) REGULATIONS 2015**

The Construction (Design and Management) Regulations 2015 (CDM) are important for designers to consider, ensuring that penetration seals and services can be installed and maintained safely.

These regulations require the production of a Construction Phase Plan for activities taken during construction and a Health and Safety File to be produced following completion of the project. The regulations allocate roles and responsibilities to key parties, from client through to contractors undertaking the actual works.

Also covered in these regulations is the requirement to plan for emergencies, including fire during construction (see section 5), alterations and maintenance operations.

The CDM regulations, roles and responsibilities apply to:

### **Clients, commercial and domestic**

Clients must make sure that they make suitable arrangements for managing a project and that required duty holders are appointed, that relevant information is prepared and provided to other duty holders, that welfare facilities are provided, and that the principal designer and principal contractor carry out their duties under CDM.

### **Designers**

All designers must eliminate, reduce or control foreseeable risks that may arise during construction or maintenance when preparing or modifying designs. They must also provide relevant information to other members of the project team.

### **Principal designers**

Principal designers are responsible for planning, managing and coordinating health and safety in the pre-construction phase of the project (everything up to work starting on site). This includes preparing and providing relevant information to other duty holders, identifying, eliminating or controlling foreseeable risks, ensuring designers carry out their duties and liaising with the principal contractor to help in the planning, management and monitoring of the construction phase.

### **Principal contractors**

Principal contractors are responsible for planning, managing, monitoring and coordinating the construction phase of the project, including preparing the construction phase plan, organising cooperation between contractors and

coordinating their work and liaising with the client and principal designer. They must ensure that suitable site inductions are provided, prevent unauthorised access, provide welfare facilities and consult and engage workers on health and safety matters.

### **Contractors**

A contractor is anyone who directly employs or engages construction workers or manages construction work.

### **Workers**

Workers must be consulted on matters that affect their health, safety and welfare. They must take care of their own health and safety and those who may be affected by their actions, and report anything they see that may endanger their own or others' health and safety. They must also cooperate with their employer, other workers, contractors and other duty holders.

## **A.4 BRITISH STANDARDS**

### **A.4.1 BS 9999**

BS 9999 [36](#) gives recommendations and guidance on the design, management and use of buildings to achieve reasonable standards of fire safety for all people in and around them. It also provides guidance on the ongoing management of fire safety within a building throughout its entire life cycle, including guidance for designers to ensure that the overall design of a building assists and enhances the management of fire safety.



#### A.4.2 BS 9991

BS 9991 [37](#) gives recommendations and guidance on the design, management and use of residential buildings so that they attain reasonable standards of fire safety for all the people who are in and around them.  
[bsigroup.com/en-GB/standards/](http://bsigroup.com/en-GB/standards/)



#### BESA DW/145

DW/145 [41](#) highlights the basic principles in the design and installation process. It also identifies the responsibilities of designers, builders, manufacturers, local authorities, mechanical services, ductwork and other specialist contractors. It identifies, clearly and concisely, the matters that must be addressed when fire and / or smoke dampers are to be installed within a building's ventilation ductwork system.

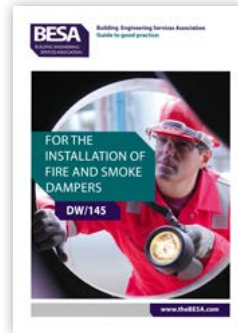

### A.5 INDUSTRY GUIDANCE

#### ASFP COLOUR BOOKS

The ASFP produces seven 'colour books', some of which are referenced in Approved Document B, and these provide the definitive guidance on a range of passive fire protection measures used in construction:

##### Grey book

Fire dampers

##### Yellow book

Fire protection for structural steel in buildings

##### Blue book

Fire resisting ductwork

##### Blue book

Fire resisting ductwork (european version)

##### Purple book

Fire resisting partitions

##### Orange book

Fire retardant coating systems

##### Red book

Firestopping: linear joint seals, penetration seals and cavity barriers [32](#)

#### BESA DW/144: SPECIFICATION FOR SHEET METAL DUCTWORK

DW/144 is the standard specification for ductwork manufacture and installation and is aligned to all current BS, BS EN ISO and other standards and regulations. It defines specifications for sheet metal ductwork for low, medium and high pressure / velocity air systems and covers ductwork application, materials, classification and air leakage. It highlights the technical



information to be provided by system designers to ductwork contractors and looks in detail at rectangular, circular and flat oval ductwork. It also contains updated information on hangers and supports, smoke and fire dampers, external ductwork, internal duct linings, thermal insulation and air terminal units, with many clear reference tables.

## DESIGN AND INSTALLATION OF SERVICE PENETRATIONS



### MANCHESTER ENGINEERING CAMPUS DEVELOPMENT (MECD)

It should be noted that the findings in this case study are project-specific and therefore could vary on other projects depending upon the passive firestopping products and services design.

Late in 2016, Balfour Beatty secured the contract to deliver the largest single construction project ever undertaken at a UK university – the Manchester Engineering Campus Development (MECD). MECD is home to four of the University of Manchester’s engineering schools and various research institutes, housing thousands of students and staff members.

Balfour Beatty’s design team, led by architects BDP and engineering firm Arup together with specialists at NG Bailey, embarked on the design, coordination and specification of the building services. They needed to give due regard to the interfaces and detailing of over 24,000 service penetrations. During this design exercise, the following key principles were adopted:

- There was considerable emphasis on ensuring that, following the Grenfell Tower disaster, this project was delivered using best practice passive firestopping solutions.
- The project starting position was to only use industry standard solutions to the firestopping. Engineering judgements would only be used on an exceptional basis.



Figure 34 Manchester Engineering Campus development (MECD)

- The team selected products and suppliers early in the design process as part of a collaborative approach. This extended to the drylining system installer, the firestopping product manufacturer and also the acoustic consultant, as service penetrations are known to contribute to flanking sound paths.
- A single authority was appointed to carry out all firestopping, and they operated a fully auditable system to capture every step of the firestopping process.
- In addition, a site-based dedicated fire compliance manager was appointed, along with an independent fire certifier, with the project team defining and agreeing responsibilities at each stage of the project.
- One of the early decisions was to agree the firestopping rules for the project together with critical dimensions, which included agreed site construction tolerances (see figure 35). This approach has been presented to various stakeholders, including the Ministry of Housing, communities and local government, which concluded that this approach was a best practice example.

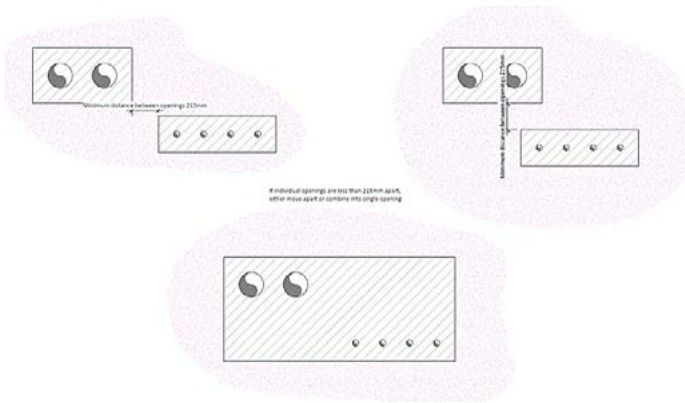

**Figure 35 Rules were defined that were applied to all service penetrations based on standard firestopping details**

### The approach

The team started by producing a series of reports, which included approved details, penetration rules, schedules of services and their associated treatment, together with evidence of the decision-making process and any evaluation judgements.

3D modelling was used in a BIM process to model all the openings (see figure 36).

Each penetration was given a unique reference and setting-out position to allow the drylining contractor to create them before the services were installed (see figure 37).

### Firestopping - design and starting position

It was important to understand the project design starting position between the client-designed Work Stage 4a and the contractors' installation design.

The design was developed by various specialist suppliers and contractors between Work Stage 4 and Work Stage 5 as a greater degree of detail and information was added into the project BIM model.

During the development it became clear that the spacing of stacked services had not been fully considered.

This was particularly evident where there were horizontal services in the door head zones, which required rerouting to avoid a clash with the structural steelwork and firestopping rules.

There was also an issue where insufficient thought was given to the drylining framework above door jamb zones and service penetrations directly above.

The service zones had to be redesigned to avoid the door jambs where possible. However, some instances required additional secondary steelwork frames to be designed and installed to accommodate the services and support the doors.

To ensure compliance, every penetration was reviewed to ensure they missed any framework and to

check that the performance of the firestopping hadn't been compromised.

Penetrations through concrete core walls were initially designed as a single slot with no cognisance of the infill material required to fire stop the opening and the associated services passing through the slot. These openings were reviewed individually to ensure the spacing requirements between services was correct.

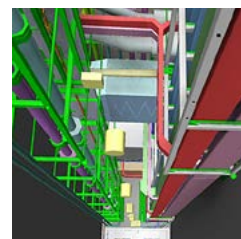
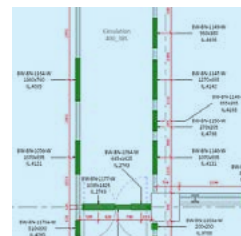

**Figure 36 BIM model used to general builders work drawing showing service penetrations**



**Figure 37 Penetrations created by dry lining contractor before services were installed**

The risers had also been sized and constructed based on 2D drawings at Work Stage 4. However, when the detail that was included on the full schematics was developed within the 3D model, it was found that unmodelled information such as drainage cross-vents required the pipework to be spaced further apart. Other specialist Contractor's Designed Portion (CDP) elements including sprinklers also had an impact on the original design.

As a result of the late incorporation of some CDP packages, services had to be coordinated and relocated to adjacent risers.

The original design specified intumescent collars for the plastic process ductwork and the penetrations were therefore defined on that basis. However, during the review process, the field of application for the selected collar was determined to be unsuitable. As a result of this, the penetrations were modified and stainless fire dampers were installed in place of the intumescent collars.

### **Sequence of installation**

1. The partitioning subcontractor installed the openings then signed them over to the M&E subcontractor.
2. The M&E subcontractor installed the services and signed the openings to the firestopping subcontractor.

3. The firestopping subcontractor installed the fire rated insulation to the pipework (500mm either side of the compartment line), closed the openings with ablative batt, then signed them back to the services M&E subcontractor.
4. The M&E subcontractor then thermally insulated the pipework and foil-wrapped both to maintain the vapour barrier.

### **Bracket spacing**

Bracket spacings either side of fire compartments were initially installed in accordance with industry standards for individual services (eg pipework). This was identified as incorrect and bracket spacings were reconfigured to be a maximum of 500mm either side of the penetration, as specified in the tested and approved standard detail.

### **Flanges within 500mm of an ablative batt**

On some compartment walls, the pipework flanges were within the fire rated insulation 500mm access zone, and in these instances, larger pieces of fire rated insulation were installed over the flanges.

### **Sleeved pipework**

Fire rated insulation was used in lieu of sleeves. This solution had the added advantage of allowing lateral pipework movement resulting from expansion.

### **Drilled services**

Individual penetrations through concrete and blockwork were assessed for every service, referencing the following:

**Figure 38 Sequence of installation**

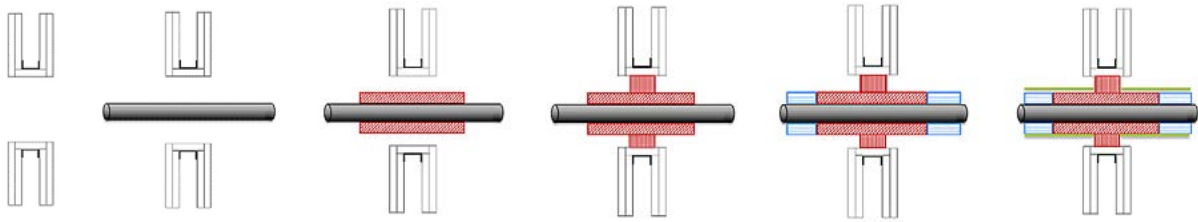

- System
- Material
- Pipe product / specification
- Size including pipe outside diameter
- Thermal insulation / fire rated insulation
- Includes electrical basket.

The architects then advised the construction team what size drill bit to use.

This included the treatment to be provided around the service together with any annular dimensions – ie remove thermal insulation and install 20-40mm fire rated insulation.

### **The detail**

Everything installed was reviewed and scrutinised for the relevant compliance.

This information was checked with the system supplier to ensure that the correct size penetrations and firestopping was specified, detailed and installed correctly.

### **The rules**

The project team agreed to adopt a standard approach across the project using one system owner's products. Rules were defined that would be applied across all service penetrations, irrespective of the wall's fire performance.

Site tolerances were added to the separation distances to allow for construction / fabrication inaccuracies.

### **BIM modelling**

The rules were communicated to the designers and BIM coordinators working on the 3D model.

### **The rules - pipework**

The pipework rules were modified after confirmation was received regarding the omission of sleeves. The spacing could then be reduced in line with the appropriate pipework test data.

In each case, the spacings were agreed and this information was recorded and passed to the responsible person in the design team.

### **The rules - cable basket**

Cable baskets were originally designed with a 50mm spacing. However, this could be reduced to the services touching the side of the opening on fire-rated penetrations. These could also be installed touching another cable basket.

### **The rules - trunking**

The system supplier confirmed that a 100x100mm cable trunking would achieve a 120-minute rating when it touched the edge of the fire-rated penetration by packing the trunking with 300mm of fire rated insulation central to the fire compartment, provided that the trunking was installed 50mm away from any other services.



## Conclusions

- Early assessment of spatial allowances within the consultant's design for integration of tested and approved fire stopping solutions proved essential. However, the construction team still found numerous examples of where there was insufficient space to incorporate tested and approved solutions. As a result, it was necessary to develop and obtain approval for non-standard fire stopping solutions.
- A penetration strategy across the project with a single authority in place to oversee the project at all stages proved invaluable.
- Responsibilities for individuals in the team were agreed from the outset and this helped to reduce ambiguity.
- Products were selected early in the process and the system supplier engaged in all early design decisions which avoided unnecessary re-coordination and design.
- A set of firestopping rules were defined with critical dimensions that included construction tolerances.
- Engineering judgements were only considered by absolute exception and then only agreed at the most senior level.

Each project can be considered an opportunity to review and learn lessons from other projects, industry guidance and previous experience within the design team.

This case study is an example of such a learning opportunity and was produced to extend the learning beyond the delivery team to the wider company.

It stands as an example of good practice. The full presentation can be found [youtube.com/watch?v=X54PP1PLtTM](https://www.youtube.com/watch?v=X54PP1PLtTM)

# REFERENCES

- 1** **Royal Institution of British Architects Plan of Work 2020**  
[ribaplanofwork.com](http://ribaplanofwork.com)
- 2** **Association for Specialist Fire Protection Advisory Note 17 ASFP position on assessments and technical evaluations in lieu of fire testing**  
[data.asfp.org.uk/default.php?cmd=210&doc\\_category=241](http://data.asfp.org.uk/default.php?cmd=210&doc_category=241)
- 3** **Passive Fire Protection Forum Guide to undertaking technical assessments of the fire performance of construction products based on fire test evidence**  
[pfpf.associationhouse.org.uk/default.php?cmd=210&doc\\_category=308](http://pfpf.associationhouse.org.uk/default.php?cmd=210&doc_category=308)
- 4** **Association for Specialist Fire Protection advice Fire and your legal liability**  
[data.asfp.org.uk/default.php?cmd=210&doc\\_category=241](http://data.asfp.org.uk/default.php?cmd=210&doc_category=241)
- 5** **The Industry Response Group Steering Group on Competence for Building a Safer Future Raising the Bar Interim Report Annex B Report – Working Group 4 – Fire Risk Assessors**  
[cic.org.uk/admin/resources/raising-the-barinterimfinal-1.pdf](http://cic.org.uk/admin/resources/raising-the-barinterimfinal-1.pdf)
- 6** **Approved Document B Fire Safety Volume 1 Dwellings**  
[gov.uk/government/publications/fire-safety-approved-document-b](http://gov.uk/government/publications/fire-safety-approved-document-b)
- 7** **Approved Document B Fire Safety Volume 2 Buildings other than Dwellings**  
[gov.uk/government/publications/fire-safety-approved-document-b](http://gov.uk/government/publications/fire-safety-approved-document-b)
- 8** **BS 7974:2019 Application of fire safety engineering principles to the design of buildings. Code of practice**  
[shop.bsigroup.com/ProductDetail?pid=000000000030353758](http://shop.bsigroup.com/ProductDetail?pid=000000000030353758)
- 9** **Association for Specialist Fire Protection Advisory Note 15 ASFP position on the Interchangeability of Supporting Construction for Firestopping**  
[data.asfp.org.uk/default.php?cmd=210&doc\\_category=241](http://data.asfp.org.uk/default.php?cmd=210&doc_category=241)
- 10** **BS EN 1366 series Fire resistance tests for service installations**  
[shop.bsigroup.com/SearchResults/?q=BS%20EN%201366](http://shop.bsigroup.com/SearchResults/?q=BS%20EN%201366)
- 11** **BS EN 1366-1:2014 Fire resistance tests for service installations. Ventilation ducts**  
[shop.bsigroup.com/ProductDetail?pid=000000000030289238](http://shop.bsigroup.com/ProductDetail?pid=000000000030289238)
- 12** **BS EN 1366-3:2009 Fire resistance tests for service installations. Penetration seals**  
[shop.bsigroup.com/ProductDetail?pid=000000000030212207](http://shop.bsigroup.com/ProductDetail?pid=000000000030212207)
- 13** **BS EN 13501-1:2018 Fire classification of construction products and building elements. Classification using data from reaction to fire tests**  
[shop.bsigroup.com/ProductDetail?pid=000000000030348263](http://shop.bsigroup.com/ProductDetail?pid=000000000030348263)
- 14** **BS EN 13501-2:2016 Fire classification of construction products and building elements. Classification using data from fire resistance tests, excluding ventilation services**  
[shop.bsigroup.com/ProductDetail?pid=000000000030410030](http://shop.bsigroup.com/ProductDetail?pid=000000000030410030)
- 15** **BS 476 series of standards Fire tests on building materials and structures**  
[shop.bsigroup.com/SearchResults/?q=BS%20476](http://shop.bsigroup.com/SearchResults/?q=BS%20476)
- 16** **BS 476-20:1987 Fire tests on building materials and structures. Method for determination of the fire resistance of elements of construction (general principles)**  
[shop.bsigroup.com/ProductDetail?pid=000000000030296644](http://shop.bsigroup.com/ProductDetail?pid=000000000030296644)
- 17** **BS 476-22:1987 Fire tests on building materials and structures. Method for determination of the fire resistance of non-loadbearing elements of construction**  
[shop.bsigroup.com/ProductDetail?pid=000000000030296646](http://shop.bsigroup.com/ProductDetail?pid=000000000030296646)
- 18** **Association for Specialist Fire Protection Advisory Note 10 'Framing Out' of Drywall Partitions**  
[data.asfp.org.uk/default.php?cmd=210&doc\\_category=241](http://data.asfp.org.uk/default.php?cmd=210&doc_category=241)
- 19** **BESA Technical Bulletin VH001 Fire and Smoke Damper Maintenance**  
[thebesa.com/knowledge/shop/products/vh001-fire-and-smoke-damper-maintenance/](http://thebesa.com/knowledge/shop/products/vh001-fire-and-smoke-damper-maintenance/)

- 20 FIS Best Practice Guide Maintenance and access into suspended Ceilings**  
[thefis.org/membership-hub/publications/best-practice-guides/](https://thefis.org/membership-hub/publications/best-practice-guides/)
- 21 BS EN 1329-1:2014+A1:2018 Plastics piping systems for soil and waste discharge (low and high temperature) within the building structure. Unplasticized poly(vinyl chloride) (PVC-U). Specifications for pipes, fittings and the systems**  
[shop.bsigroup.com/ProductDetail?pid=000000000030347800](https://shop.bsigroup.com/ProductDetail?pid=000000000030347800)
- 22 BS EN 1451-1:2017 Plastics piping systems for soil and waste discharge (low and high temperature) within the building structure. Polypropylene (PP). Specifications for pipes, fittings and the system**  
[shop.bsigroup.com/ProductDetail?pid=000000000030405665](https://shop.bsigroup.com/ProductDetail?pid=000000000030405665)
- 23 BS EN 1455-1:2000 Plastics piping systems for soil and waste (low and high temperature) within the building structure. Acrylonitrile-butadiene-styrene (ABS). Specifications for pipes, fittings and the system**  
[shop.bsigroup.com/ProductDetail?pid=000000000030085408](https://shop.bsigroup.com/ProductDetail?pid=000000000030085408)
- 24 BS EN 1519-1:2019 Plastics piping systems for soil and waste discharge (low and high temperature) within the building structure. Polyethylene (PE). Requirements for pipes, fittings and the system**  
[shop.bsigroup.com/ProductDetail/?pid=000000000030405664](https://shop.bsigroup.com/ProductDetail/?pid=000000000030405664)
- 25 BS EN 1566-1:2000 Plastics piping systems for soil and waste discharge (low and high temperature) within the building structure. Chlorinated poly(vinyl chloride) (PVC-C). Specification for pipes, fittings and the system**  
[shop.bsigroup.com/ProductDetail?pid=000000000030085763](https://shop.bsigroup.com/ProductDetail?pid=000000000030085763)
- 26 British Automatic Fire Sprinkler Association BIF No 8D Information File: CPVC Fire Sprinkler Systems**  
[thenbs.com/PublicationIndex/documents/details?Pub=BAFSA&DocID=324363](https://thenbs.com/PublicationIndex/documents/details?Pub=BAFSA&DocID=324363)
- 27 Finishes and Interiors Sector Technical note – Compatibility between pipes and fire and acoustic seals**  
[thefis.org/members-login/?redirect\\_to=/wp-content/uploads/2019/12/Compatibility-between-pipes-and-fire-and-acoustic-seals.pdf](https://thefis.org/members-login/?redirect_to=/wp-content/uploads/2019/12/Compatibility-between-pipes-and-fire-and-acoustic-seals.pdf)
- 28 Association for Specialist Fire Protection Advisory Note 13 ASFP Position on Partial Penetrations**  
[data.asfp.org.uk/default.php?cmd=210&doc\\_category=241](https://data.asfp.org.uk/default.php?cmd=210&doc_category=241)
- 29 Association for Specialist Fire Protection Advisory Notice Using Polyurethane Foams**  
[data.asfp.org.uk/default.php?cmd=210&doc\\_category=241](https://data.asfp.org.uk/default.php?cmd=210&doc_category=241)
- 30 European Assessment Document EAD 350454-00-1104 Fire stopping and fire sealing products - Penetration seals**  
[eota.eu](https://eota.eu)
- 31 Dame Judith Hackitt Building a Safer Future Independent Review of Building Regulations and Fire Safety: Final Report May 2018 Cm 9607**  
[gov.uk/government/publications/independent-review-of-building-regulations-and-fire-safety-final-report](https://gov.uk/government/publications/independent-review-of-building-regulations-and-fire-safety-final-report)
- 32 Association for Specialist Fire Protection Red Book – Fire-stopping: Linear joint seals, penetration seals and cavity barriers**  
[data.asfp.org.uk/default.php?cmd=210&doc\\_category=121](https://data.asfp.org.uk/default.php?cmd=210&doc_category=121)
- 33 Association for Specialist Fire Protection Advisory Note 8 Issues surrounding service support centres**  
[data.asfp.org.uk/default.php?cmd=210&doc\\_category=241](https://data.asfp.org.uk/default.php?cmd=210&doc_category=241)
- 34 Association for Specialist Fire Protection Technical Guidance Document - TGD 17 Code of practice for the installation and inspection of fire stopping systems in buildings: Linear joint seals, penetration seals, small cavity barriers**  
[data.asfp.org.uk/default.php?cmd=210&doc\\_category=16](https://data.asfp.org.uk/default.php?cmd=210&doc_category=16)
- 35 Risk Insight, Strategy and Control Authority and Fire Protection Association Approved Document B: Fire Safety (Volume 2: Buildings other than Dwellinghouses) Incorporating Insurers' Requirements for Property Protection**  
[thefpa.co.uk](https://thefpa.co.uk)
- 36 BS 9999:2017 Fire safety in the design, management and use of buildings. Code of practice**  
[shop.bsigroup.com/ProductDetail?pid=000000000030357099](https://shop.bsigroup.com/ProductDetail?pid=000000000030357099)

- 37** **BS 9991:2015 Fire safety in the design, management and use of residential buildings. Code of practice**  
[shop.bsigroup.com/  
ProductDetail?pid=000000000030351309](http://shop.bsigroup.com/ProductDetail?pid=000000000030351309)
- 38** **Department for children, schools and families Building Bulletin 100: Design for fire safety in schools**  
[gov.uk/government/publications/building-bulletin-100-design-for-fire-safety-in-schools](http://gov.uk/government/publications/building-bulletin-100-design-for-fire-safety-in-schools)
- 39** **Department of Health Health Technical Memorandum 05-02: Firecode Guidance in support of functional provisions (Fire safety in the design of healthcare premises)**  
[gov.uk/government/publications/guidance-in-support-of-functional-provisions-for-healthcare-premises](http://gov.uk/government/publications/guidance-in-support-of-functional-provisions-for-healthcare-premises)
- 40** **BSRIA BG 6/2018 Design Framework for Building Services 5<sup>th</sup> Edition**  
[bsria.com/uk/product/gDXyjB/design\\_framework\\_for\\_building\\_services\\_5th\\_edition\\_bg\\_62018\\_a15d25e1/](http://bsria.com/uk/product/gDXyjB/design_framework_for_building_services_5th_edition_bg_62018_a15d25e1/)
- 41** **BESA DW/145 Guide to Good Practice for the Installation of Fire and Smoke Dampers**  
[thebesa.com/knowledge/shop/products/dw-145-guide-to-good-practice-for-the-installation-of-fire-and-smoke-dampers/](http://thebesa.com/knowledge/shop/products/dw-145-guide-to-good-practice-for-the-installation-of-fire-and-smoke-dampers/)
- 42** **Association for Specialist Fire Protection Advisory Note 1 'Safe use of Horizontal firestopping**  
[data.asfp.org.uk/default.php?cmd=210&doc\\_category=241](http://data.asfp.org.uk/default.php?cmd=210&doc_category=241)
- 43** **Fire Protection Association – The Joint Code of Practice Fire Prevention on Construction Sites and Checklist**  
[thefpa.co.uk//index.cfm?originalUrl=shop/shop\\_product\\_details.EAC93171-BAEA-45D1-95784B50DCA27065.html&shop\\_category=DEC2ADFB-B816-4043-B83BB310703D36B8](http://thefpa.co.uk//index.cfm?originalUrl=shop/shop_product_details.EAC93171-BAEA-45D1-95784B50DCA27065.html&shop_category=DEC2ADFB-B816-4043-B83BB310703D36B8)
- 44** **BESA online service**  
[sfg20.co.uk](http://sfg20.co.uk)

# ACKNOWLEDGEMENTS

This guide has been made possible with support and contributions from the following trade associations:



**ASFP** (Association for Specialist Fire Protection) is the UK's leading trade association for the passive fire protection sector. It serves and represents the needs of its members and the wider passive fire protection industry by raising standards and competence through training, testing, certification and quality of installation and maintenance. It aims to advance knowledge and guidance on all aspects of 'built-in' fire protection; provide technical support and impartial advice; lead regulatory and behavioural change as an independent authority; and improve competence and quality through training.  
**asfp.org.uk**



**BESA** (Building Engineering Services Association) is the UK's leading trade organisation for building engineering services contractors – representing the interests of firms active in the design, installation, commissioning, maintenance, control and management of engineering systems and services in buildings.  
**thebesa.com**



**BSRIA** (Building Services Research and Information Association) is a non-profit distributing, member-based association promoting knowledge and providing specialist services for construction and building services stakeholders.  
**bsria.com/uk/**



**FIS** (Finishes and Interiors Sector) is the not-for-profit representative body for the £10billion finishes and interiors sector in the UK. The organisation exists to support its members, improve safety, minimise risk, enhance productivity and drive innovation in the sector.  
**thefis.org**



**GPDA** (Gypsum Products Development Association) represents the four major gypsum board and plaster manufacturers in the UK and Ireland. Its primary function is to develop and encourage the understanding of gypsum-based building products and systems. It has an ongoing commitment to advise on matters of environmental impact, energy conservation and health and safety, wherever gypsum-based products are used.  
**gpda.com**

# ACKNOWLEDGEMENTS

We also acknowledge the contributions from the following steering group members:

**Craig Abbott** FSI

**Carl Atkinson** FSI

**David Bleicher** BSRIA

**Joe Cilia** FIS

**Alex Double** ADDC

**Rob Lambert** Skanska

**Nicholas Mead** Laing O'Rourke

**Ross Newman** Warringtonfire

**Will Pitt** NG Bailey and BESA

**Dave Robinson** GPDA

**Peter Rogers** BESA

**Matthew Sexton**

**James Smith** NBS

**Andrew Taylor** ASFP

**Bob Westcombe** ROCKWOOL UK

# NOTES



ASFP  
Spectra House  
Westwood Way  
Coventry CV4 8HS

+44 (0)2476 935 412  
info@asfp.org.uk  
asfp.org.uk



BESA  
Old Mansion House  
Eamont Bridge  
Penrith CA10 2BX

+44 (0)1768 860 465  
enquiries@thebesa.com  
thebesa.com



BSRIA  
Old Bracknell Lane West  
Bracknell RG12 7AH

+44 (0)1344 465 600  
bsria@bsria.co.uk  
bsria.com/uk/



FIS  
Olton Bridge  
245 Warwick Road  
Solihull B92 7AH

+44 (0)121 707 0077  
info@thefis.org  
thefis.org



GPDA  
19 Omega Business Village  
Thurston Road  
Northallerton DL6 2NJ

+44 (0)20 8253 4515  
admin@gpda.com  
gpda.com